

Product Manual

UNO-DM-1.2/2.0/3.3/4.0/4.6/5.0-TL-PLUS

(from 1.2 to 5.0 kW)



IMPORTANT SAFETY INSTRUCTIONS



This manual contains important safety instructions that must be followed during the installation and maintenance of the equipment.

SAVE THESE INSTRUCTIONS!



Keep this document in a safe place near the inverter for easy access during installation, operation and maintenance.

THE INSTALLER MUST READ THIS DOCUMENT IN ITS ENTIRETY BEFORE INSTALLING THIS EQUIPMENT.

Operators are required to read this manual and scrupulously follow the instructions given in it, since ABB cannot be held responsible for damage caused to people and/or things, or the equipment, if the conditions described below are not observed.

The purpose of this document is to support the qualified technician, who has received training and/or has demonstrated skills and knowledge in construction, to install, operate and maintain the inverter. This manual covers only inverter, not any equipment (photovoltaic modules, external disconnects, etc) to which it is connected.

Warranty requirements are included in the Terms and Conditions of sale included with the inverter order.

NOTE: Any changes made to the product or to the installation conditions that hasn't been approved by ABB will void the warranty.



All pictures and illustrations shown in this user manual are indicatives and must be intended as support for installation instruction only. Actual product may vary due to product enhancement. Specifications subject to change without notice. The latest version of this document is available on the ABB website.



The products are designed to be connected to and to communicate information and data via a network interface. It is the user's sole responsibility to provide and continuously ensure a secure connection between the product and the user's network or any other network (as the case may be). The user shall establish and maintain any appropriate measures (such as but not limited to the installation of firewalls, application of authentication measures, encryption of data, installation of anti-virus programs, etc) to protect the product, the network, its system and the interface against any kind of security breaches, unauthorized access, interference, intrusion, leakage and/or theft of data or information. ABB and its affiliates are not liable for damages and/or losses related to such security breaches, any unauthorized access, interference, intrusion, leakage and/or theft of data or information. The data, examples and diagrams in this manual are included solely for the concept or product description and are not to be deemed as a statement of guaranteed properties. All persons responsible for applying the equipment addressed in this manual must satisfy themselves that each intended application is suitable and acceptable, including that any applicable safety or other operational requirements are complied with. In particular, any risks in applications where a system failure and/or product failure would create a risk for harm to property or persons (including but not limited to personal injuries or death) shall be the sole responsibility of the person or entity applying the equipment, and those so responsible are hereby requested to ensure that all measures are taken to exclude or mitigate such risks. This document has been carefully checked by ABB but deviations cannot be completely ruled out. In case any errors are detected, the reader is kindly requested to notify the manufacturer. Other than under explicit contractual commitments, in no event shall ABB be responsible or liable for any loss or damage resulting from the use of this manual or the application of the equipment.

Product Manual

UNO-DM-1.2/2.0/3.3/4.0/4.6/5.0-TL-PLUS string inverters

1 - Introduction and general information



2 - Characteristics



3 - Safety and accident prevention



4 - Lifting and transport



5 - Installation



6 - Instruments



7 - Operation



8 - Maintenance



9 - Attachments



Warranty and supply conditions

The warranty conditions are considered to be valid if the Customer adheres to the indications in this manual; any conditions deviating from those described herein must be expressly agreed in the purchase order.

ABB declares that the equipment complies with the provisions of law currently in force in the country of installation and has issued the corresponding declaration of conformity.

Not included in the supply

ABB accepts no liability for failure to comply with the instructions for correct installation and will not be held responsible for systems upstream or downstream of the equipment it has supplied.



It is absolutely forbidden to modify the equipment. Any modification, manipulation, or alteration not expressly agreed with the manufacturer, concerning either hardware or software, shall result in the immediate cancellation of the warranty.

The customer is fully responsible for any changes made to the system.

Given the countless array of system configurations and installation environments possible, it is essential to check the following: adequate spaces, suitable for housing the equipment; airborne noise produced based on the environment; possible flammability conditions.

ABB will NOT be held liable for defects or malfunctions arising from: improper use of the equipment; deterioration resulting from transportation or particular environmental conditions; performing maintenance incorrectly or not at all; tampering or unsafe repairs; use or installation by unqualified persons.

ABB is not responsible for any loss of the equipment, or part of it, which does not take place on the basis of the regulations and laws in force in the country of installation.

Table of Contents

Introduction and general information	4
Warranty and supply conditions	4
Not included in the supply.....	4
Table of Contents	5
Reference number index	9
Graphical representation of references	9
Accessory Board UNO-DM-COM KIT	
(Only -X models or as optional accessory)	10
Accessory Board UNO-DM-PLUS-COM Ethernet KIT	
(Only -E models or as optional accessory)	11
REACT-MTR-1PH energy meter	12
ABB B23, B24 3PH energy meter	12
ABB B21 1PH energy meter	13
Scope and target audience	14
Purpose and document structure	14
List of appendix documents	14
Operator and maintenance personnel skills/prerequisites	14
Symbols and signs	15
Field of use, general conditions	17
Intended or allowed use.....	17
Limits in field of use.....	17
Improper or prohibited use	17
Characteristics	18
General conditions	18
Models and range of equipment	19
Identification of the equipment and manufacturer	20
Characteristics and technical data	22
Tightening torques	28
Overall dimensions	28
Bracket dimensions.....	29
Curve di efficienza	30
Limitazione di potenza (Power Derating)	32
Riduzione di potenza dovuta alle condizioni ambientali.....	32
Riduzione di potenza dovuta alla tensione in ingresso	33
Characteristics of a photovoltaic generator	34
Strings and arrays.....	34
Description of the equipment	35
Operating diagram	35
Mutual connection of multiple inverters	36
Notes on the system sizing.....	36
Operating diagram	37
Functionality and components of the equipment	38
Topographic diagram of the equipment	41





Safety devices	44
Anti-Islanding	44
Ground fault of the photovoltaic panels	44
Other safety devices	44
Safety and accident prevention	45
Safety information and instructions	45
Hazardous areas and operations	46
Environmental conditions and risks	46
Signs and labels.....	46
Thermal and electrical hazard	47
Clothing and protection of personnel.....	47
Residual risks	48
Table of residual risks	48
Lifting and transport	49
General conditions	49
Transport and handling	49
Lifting.....	49
Unpacking and checking	49
List of components supplied	50
Weight of the modules of the equipment.....	51
Installation	52
General conditions	52
Environmental checks.....	53
Installations above 2000 metres	53
Wireless signal environmental checks.....	54
Recommendations for the wireless signal power	56
Installation position.....	57
Wall mounting	58
Wireless antenna mounting	59
Opening the front cover	60
Preliminary operations for connection of the PV generator	61
Checking the correct polarity of the strings	61
Checking of leakage to ground of the photovoltaic generator.....	61
Selection of differential protection downstream of the inverter	61
Independent or parallel input channels configuration	63
Channel configuration examples	64
Independent channel configuration (default configuration)	65
Parallel channel configuration	65
Input connection to PV generator (DC side)	66
Installation procedure for quick-fit connectors	68
Distribution grid output connection (AC side)	72
Characteristics and sizing of the line cable	72
Load protection switch (AC disconnect switch)	73
Installation of the cable on the AC output connector	74
Connection for the AC output connector to the inverter	76
Installation of the external protective grounding cable	77



Communication and control signal connections to the UNO-DM-COM KIT board (only for -X / -E version)	78
Description of terminal blocks on the UNO-DM-COM KIT board (only for -X version)	79
Description of terminal blocks on the UNO-DM-PLUS-COM Ethernet KIT board (only for -E version).....	80
Connection of the RS485 line	81
Remote control connection	83
Demand Responce Mode 0 (Request by AS/NZS 4777).....	83
Configurable Relay connection (ALARM / LOAD MANAGER)	84
Connection of the energy meter	85
Connection of the REACT-MTR-1PH (single-phase).....	85
Connection and configuration of the ABB B21 meter (single-phase)	87
Connection and configuration of the ABB B23, B24 3PH (three-phase).....	90
Closing the front cover	93
Instruments	94
General conditions	94
Description of keyboard and LED Panel.....	95
Operation	96
General conditions	96
Monitoring and data transmission	97
User interface	97
Measurement tolerance	97
Commissioning (Via internal Webserver)	98
Commissioning (Using the inverter display)	107
Power, Alarm, GFI LEDs behaviour	109
Specifications on operation of the LEDs.....	110
LED insulation fault	110
COMM Status, RSSI LEDs behaviour	110
Description of the internal Webserver	111
Access to the internal Webserver.....	111
webserver menu structure	114
MAIN section.....	115
SETUP section.....	116
EVENTS Section.....	118
USER section.....	119
NETWORK section	120
TOOLS section.....	124
INFORMATION Section	135
Description of the Display menus	136
General information	136
Menu structure	137
System Menu	138
Inverter Menu	140
Display Menu	154
WLAN Logger Menu	155

Maintenance	157
General conditions	157
Routine maintenance	158
Troubleshooting	159
Internal Webserver and wireless communication troubleshooting.....	159
Alarm Messages of the Inverter.....	161
Power limitation messages	170
Dismantling the inverter	172
Registration on “Registration” website and calculation of second-level password (Service menu, Admin Plus)	173
Resetting the remaining time for grid standard variation from display	176
Verification of ground leakage	177
Behaviour of a system without leakage	177
Behaviour of a system with leakage	178
Measuring the isolation resistance of the PV generator	179
Storage and dismantling	180
Storage of an uninstalled inverter for long periods.....	180
Storage of an installed inverter for long periods of non-use.....	180
Disposal.....	180
Attachments	181
Port and network services used by the inverter	181
IP Network Services.....	181
Network Hosts.....	182
Inverter network configuration	182
Further information	183
Contact us	184



Reference number index

- | | | |
|----------------------------|---|--|
| ①, Bracket | ⑧, Keyboard | ⑱, UNO-DM-COM KIT Card
(Only for -X and -E models or as optional accessory) |
| ②, Loking spring | ⑨, DC input connectors | ⑲, External earth connection |
| ③, Heat sink | ⑩, AC output connector | ⑳, Service cable glands |
| ④, Anti-condensation valve | ⑪, Wireless antenna connector | |
| ⑤, Front cover | ⑫, DC Input terminal block | |
| ⑥, LED panel | ⑬, Locking Screw | |
| ⑦, Display | ⑭, DC disconnect switch
(Only for -S models) | |



Graphical representation of references

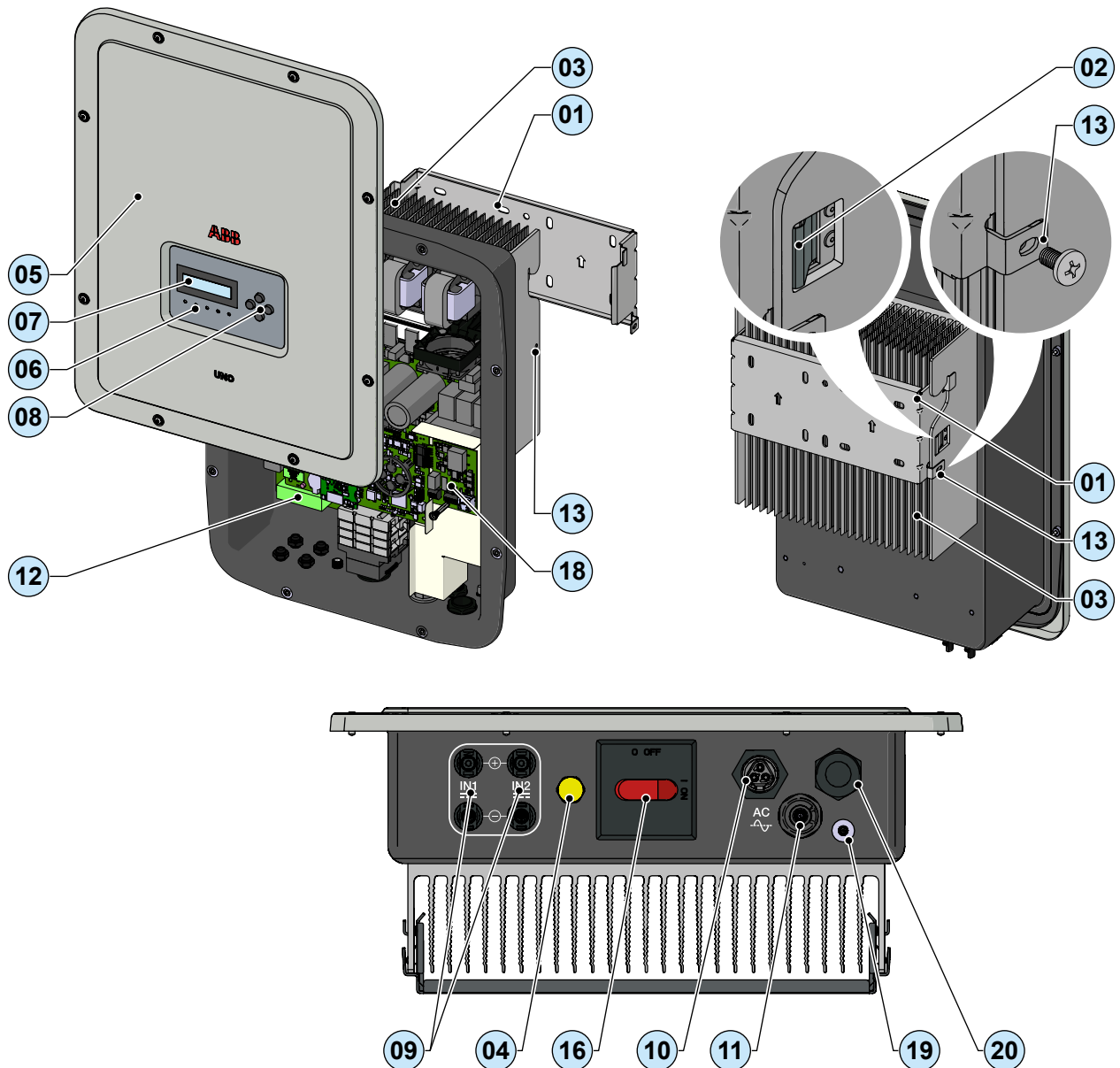

Accessory Board UNO-DM-COM KIT (Only -X models or as optional accessory)

- ②①, Inverter connector
- ②③, DRM0 activation jumper
- ②⑤, Fixing hole
- ②②, RS485 Termination line jumper
- ②④, ALARM terminal block
- ②⑥, RS485 and REM terminal block

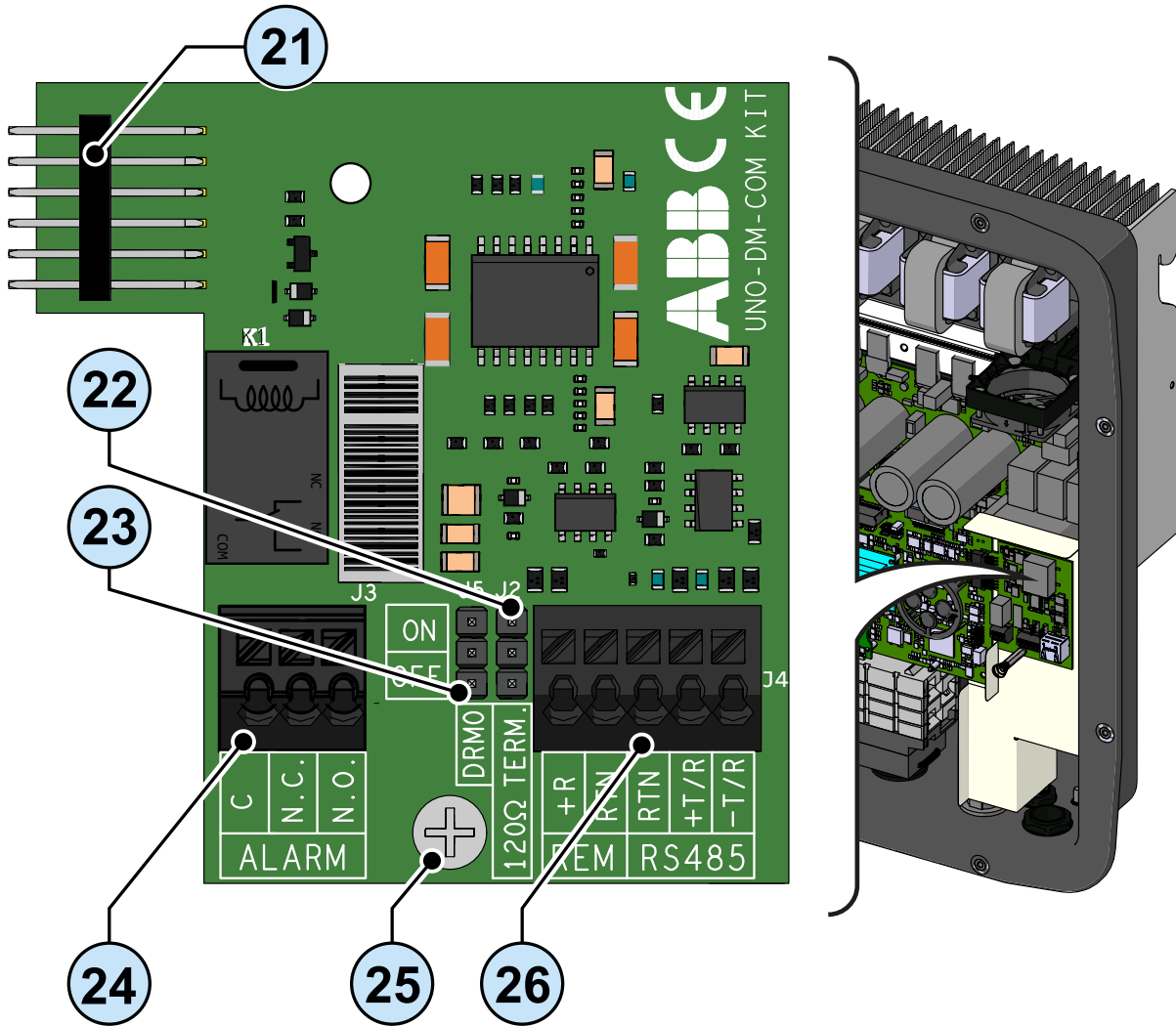

Accessory Board UNO-DM-PLUS-COM Ethernet KIT (Only -E models or as optional accessory)

- ②1, Inverter connector
- ②2, RS485 Termination line jumper
- ②3, DRM0 activation jumper
- ②4, ALARM terminal block
- ②5, Fixing hole
- ②6, RS485 and REM terminal block
- ②7, LAN Ethernet connector

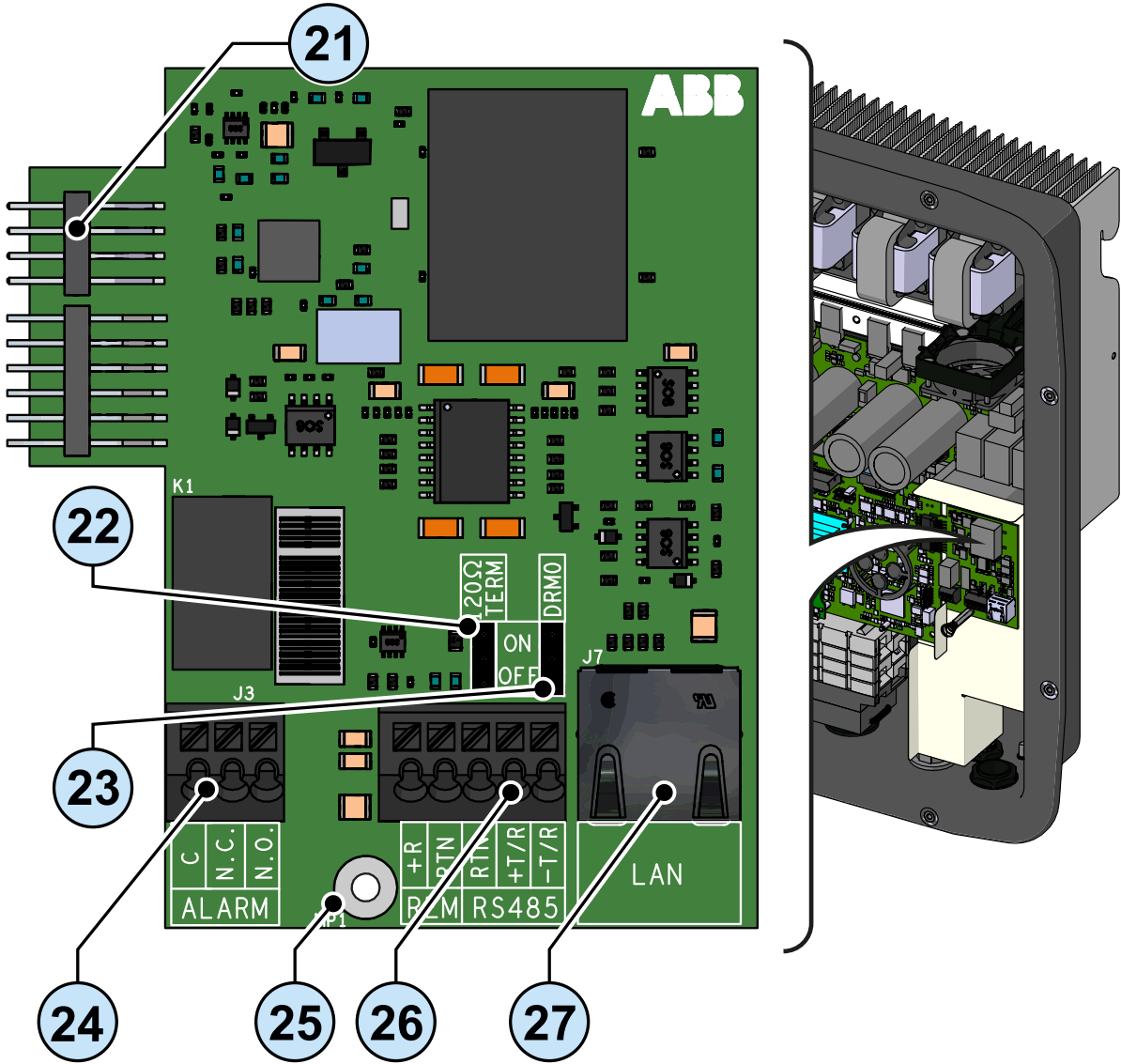

REACT-MTR-1PH energy meter

- 54, REACT-MTR-1PH
- 55, Hole for line cable
- 56, AC power supply terminal block
- 57, METER RS485 serial terminal block



ABB B23, B24 3PH energy meter

- 58, ABB B23, B24 3PH Meter
- 59, terminal block for three-phase connection
- 60, METER RS485 serial terminal block

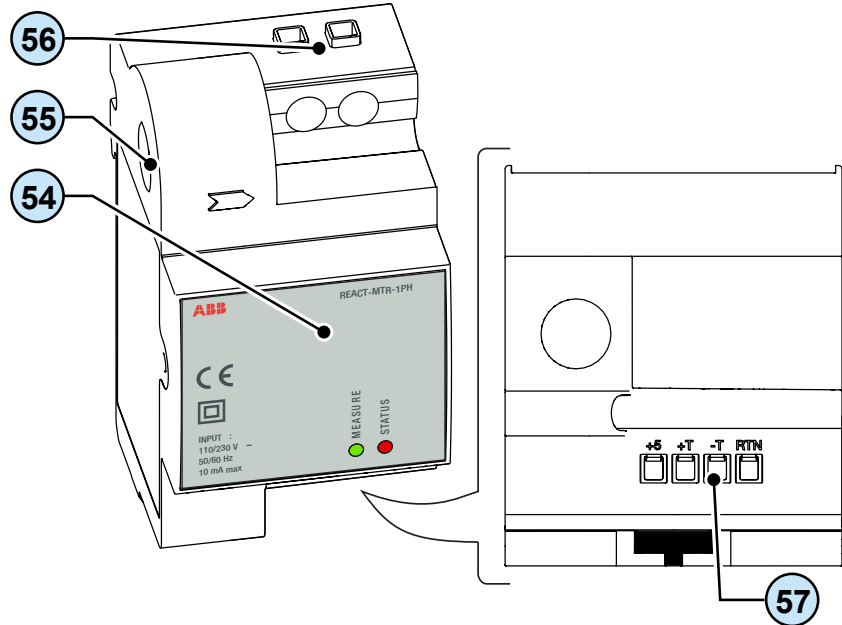

ABB B21 1PH energy meter

40, ABB B21 1PH meter

56, AC power supply terminal block

57, METER RS485 serial terminal block

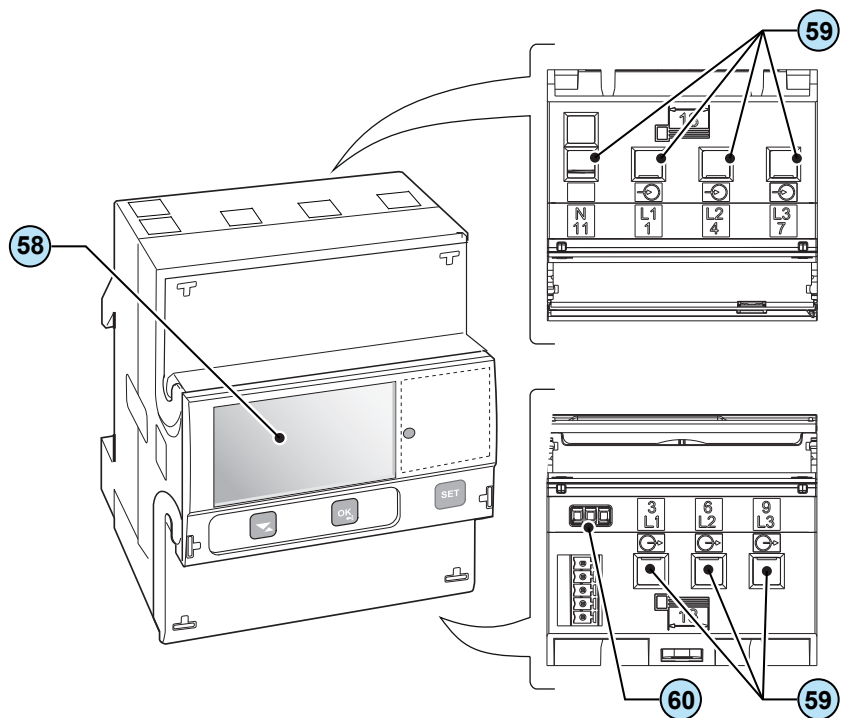
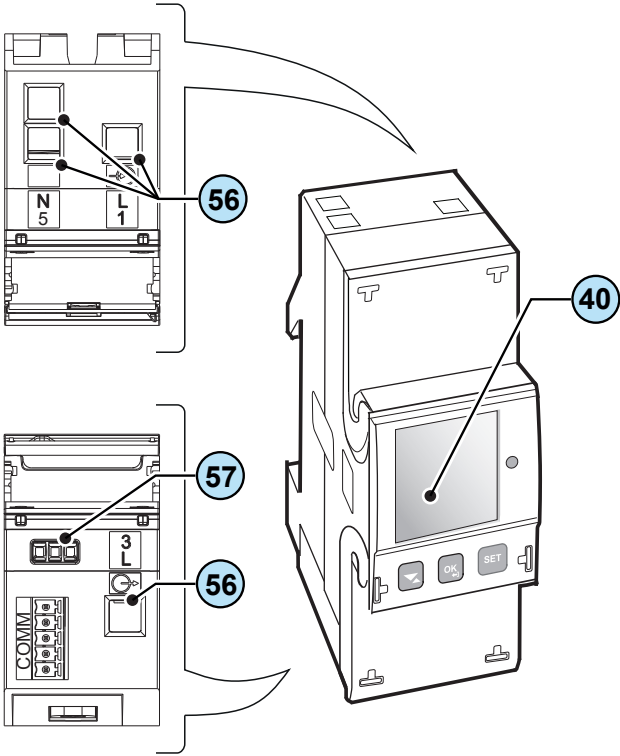

Scope and target audience

Purpose and document structure

This operating and maintenance manual is a useful guide that will enable you to work safely and carry out the operations necessary for keeping the equipment in good working order.



If the equipment is used in a manner not specified in this manual, the protection provided by the equipment may be impaired.



The language in which the document was originally written is ITALIAN; therefore, in the event of inconsistencies or doubts please ask the manufacturer for the original document.

List of appendix documents

In addition to this user manual and maintenance you can consult (and download) the product documentation by visiting www.abbsolarinverters.com.



Part of the information given in this document is taken from the original supplier documents. This document contains only the information considered necessary for the use and routine maintenance of the equipment.

Operator and maintenance personnel skills/prerequisites



Personnel in charge of using and maintaining the equipment must be skilled for the described tasks and must reliably demonstrate their capacity to correctly interpret what is described in the manual.



For safety reasons, only a qualified electrician who has received training and/or demonstrated skills and knowledge of the inverter's structure and operation may install the inverter.



The installation must be performed by qualified installers and/or licensed electricians in accordance with the existing regulations in the country of installation.







Inverter operation and maintenance by a person who is NOT qualified, is intoxicated, or on narcotics, is strictly forbidden.











The customer has civil liability for the qualification and mental or physical state of the personnel who interact with the equipment. They must always use the personal protective equipment (PPE) required by the laws of the country of destination and whatever is provided by their employer.

Symbols and signs

In the manual and/or in some cases on the equipment, the danger or hazard zones are indicated with signs, labels, symbols or icons.

Symbol	Description
	Indicates that it is mandatory to consult the manual or original document, which must be available for future use and must not be damaged in any way.
	General warning - Important safety information. Indicates operations or situations in which staff must be very careful.
	Dangerous Voltage - Indicates operations or situations in which staff must be very careful with regard to dangerous voltage levels.
	Hot parts - Indicates a risk arising from the presence of hot zones or zones with parts at high temperatures (risk of burns).
	Risk of explosion
	Risk of injury due to the weight of the equipment. Take care during lifting and transport
	Indicates that the area in question must not be accessed or that the operation described must not be carried out.
	Keep out of the reach of children
	Indicates that smoking and the use of naked flames is prohibited.
	Indicates that it is mandatory to carry out the described operations using the clothing and/or personal protective equipment provided by the employer.
	WEEE logo. Indicates that the product is to be disposed of according to current legislation regarding the disposal of electronic components.
	Indicates the protection rating of the equipment according to IEC 70-1 (EN 60529 June 1997) standard.
	Point of connection for grounding protection.
	Indicates the permitted temperature range



Symbol	Description
	Indicates a risk of electric shock. The discharge time of the stored energy (represented in the figure by the letters XX), is provided on the identification label.
	Direct Current
	Alternate current
	With isolation transformer
	Without isolation transformer
	Positive pole of the input voltage (DC)
	Negative pole of the input voltage (DC)
	Indicates the centre of gravity of the equipment.
	Indicates the requirement to wear acoustic protection devices in order to prevent damage to hearing



Field of use, general conditions

ABB shall not be liable for any damages whatsoever that may result from incorrect or careless operations.



*You may not use the equipment for a use that does not conform to that provided for in the field of use. The equipment **MUST NOT** be used by inexperienced staff, or even experienced staff if carrying out operations on the equipment that fail to comply with the indications in this manual and enclosed documentation.*



Intended or allowed use

This equipment is a inverter designed for:
transforming a continuous electrical current (DC)
supplied by a photovoltaic generator (PV)
in an alternating electrical current (AC)
suitable for feeding into the public distribution grid.

Limits in field of use

The inverter can be used only with photovoltaic modules which have ground isolated input poles, unless there are accessories installed that enable earthing of the inputs. In this case you must install an insulating transformer on the AC side of the system.

Only a photovoltaic generator can be connected in the input of the inverter (do not connect batteries or other sources of power supply).

The inverter can be connected to the electricity grid only in countries for which it has been certified/approved.

The inverter cannot be connected to the DC side in parallel to other inverters.

The inverter may only be used in compliance with all its technical characteristics.

Improper or prohibited use



IT IS STRICTLY FORBIDDEN TO:

- Install the equipment in environments subject to particular conditions of flammability or in adverse or disallowed environmental conditions, (temperature and humidity).
- Use the equipment with safety devices which are faulty or disabled.
- Use the equipment or parts of the equipment by linking it to other machines or equipment, unless expressly provided for.
- Modify operating parameters that are not accessible to the operator and/or parts of the equipment to vary its performance or change its isolation.
- Clean with corrosive products that could eat into parts of the equipment or generate electrostatic charges.
- Use or install the appliance or parts of it without having read and understood the contents of the user and maintenance manual.
- Placing any heavy object, sit or stand up on the inverter.
- Heat or dry rags and clothing on the parts in temperature. In addition to being hazardous, doing so would compromise component ventilation and cooling.



General conditions

A description of the equipment characteristics is provided to identify its main components and specify the technical terminology used in the manual.

This chapter contains information about the models, details of the equipment, characteristics and technical data, overall dimensions and equipment identification.



The customer/Installer takes full responsibility if, when reading this manual, the chronological order of its presentation provided is not observed. All information is provided considering occasional inclusion of information in previous chapters.



In certain cases, there may be a need to separately document software functionality or attach supplementary documentation to this manual which is intended for more qualified professionals.

Models and range of equipment

The models of single-phase inverters covered by this manual are divided for their maximum output power:

1.2kW, 2.0kW, 3.0kW, 3.3kW, 4.0kW, 4.6kW and 5.0kW.

For each model, the following variants are available (suffix could be combined):

- Models with “B” suffix (e.g. UNO-DM-3.3-TL-PLUS-B).

Models equipped with Wireless communication.

- Models with “S” suffix (e.g. UNO-DM-3.3-TL-PLUS-S).

Models equipped with DC disconnecting switch ¹⁶.

- Models with “E” suffix (e.g. UNO-DM-3.3-TL-PLUS-E).

Models equipped with Wireless communication and Accessory Board equipped with Ethernet board (UNO-DM-PLUS-COM Ethernet KIT) ¹⁸.

- Models with “X” suffix (e.g. UNO-DM-3.3-TL-PLUS-X).

Models equipped with Accessory Board (UNO-DM-COM KIT) ¹⁸.



The choice of the inverter model must be made by a qualified technician who knows about the installation conditions, the devices that will be installed outside the inverter and possible integration with an existing system.



Identification of the equipment and manufacturer

The technical data provided in this manual does not substitute the data supplied on the labels affixed to the equipment.



The labels affixed to the equipment must NOT be removed, damaged, stained, hidden, etc., for any reason whatsoever.



The Regulatory label contains the following information:

1. Manufacturer
2. Model
3. Rating data
4. Certification marks

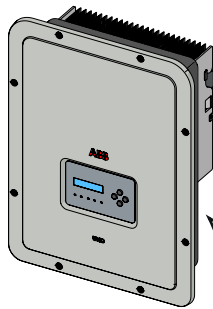

The labels are NOT to be hidden by foreign objects and parts (rags, boxes, equipment, etc.); they must be regularly cleaned and always kept in sight.





1 **ABB**   **4** Made in Italy



www.abb.com/solar SOLAR INVERTER **2** MODEL: UNO-DM-1.2-TL-PLUS-B

V _{dc} max	600 V	V _{acr}	230 V 1Ø
V _{dc} MPP	90 - 580 V	f _r	50 Hz
V _{dc} , Full Power	100 - 530 V	S _{max}	1200 VA
I _{dc} max	10 A	P _{acr} (cosφ = 1)	1200 W ⁽¹⁾
I _{sc} max	12.5 A	P _{acr} (cosφ = 0.9)	1060 W ⁽¹⁾
		A _{adj} cosφ	0.1 - 1 ⁽²⁾
		I _{sc} max	5.5 A

(1): @ 50°C amb. (2): Over/Under excited

-25 to +60 °C
-13 to +140 °F

IP65    5 minutes



1 **ABB**   **4** Made in Italy



www.abb.com/solar SOLAR INVERTER **2** MODEL: UNO-DM-2.0-TL-PLUS-B

V _{dc} max	600 V	V _{acr}	230 V 1Ø
V _{dc} MPP	90 - 580 V	f _r	50 Hz
V _{dc} , Full Power	210 - 530 V	S _{max}	2000 VA
I _{dc} max	10 A	P _{acr} (cosφ = 1)	2000 W ⁽¹⁾
I _{sc} max	12.5 A	P _{acr} (cosφ = 0.9)	1800 W ⁽¹⁾
		A _{adj} cosφ	0.1 - 1 ⁽²⁾
		I _{sc} max	10 A

(1): @ 50°C amb. (2): Over/Under excited

-25 to +60 °C
-13 to +140 °F

IP65    5 minutes



1 **ABB**   **4** Made in Italy



www.abb.com/solar SOLAR INVERTER **2** MODEL: UNO-DM-3.3-TL-PLUS-B

V _{dc} max	600 V	V _{acr}	230 V 1Ø
V _{dc} MPP	90 - 580 V	f _r	50 Hz
V _{dc} , Full Power	170 - 530 V	S _{max}	3300 VA
I _{dc} max	2 x 10 A	P _{acr} (cosφ = 1)	3300 W ⁽¹⁾
I _{sc} max	2 x 12.5 A	P _{acr} (cosφ = 0.9)	3000 W ⁽¹⁾
		A _{adj} cosφ	0.1 - 1 ⁽²⁾
		I _{sc} max	14.5 A

(1): @ 50°C amb. (2): Over/Under excited

-25 to +60 °C
-13 to +140 °F

IP65    5 minutes



1 **ABB**   **4** Made in Italy



www.abb.com/solar SOLAR INVERTER **2** MODEL: UNO-DM-4.0-TL-PLUS-B

V _{dc} max	600 V	V _{acr}	230 V 1Ø
V _{dc} MPP	90 - 580 V	f _r	50 Hz
V _{dc} , Full Power	130 - 530 V	S _{max}	4000 VA ⁽³⁾
I _{dc} max	2 x 16 A	P _{acr} (cosφ = 1)	4000 W ⁽³⁾
I _{sc} max	2 x 20 A	P _{acr} (cosφ = 0.9)	3600 W ⁽³⁾
		A _{adj} cosφ	0.1 - 1 ⁽²⁾
		I _{sc} max	17.2 A ⁽³⁾

(1): @ 50°C amb. (2): Over/Under excited (3): 3600 VA / 3600 W / 16 A for UK G83 (4): 3300 W for UK G83

-25 to +60 °C
-13 to +140 °F

IP65    5 minutes



1 **ABB**   **4** Made in Italy



www.abb.com/solar SOLAR INVERTER **2** MODEL: UNO-DM-4.6-TL-PLUS-B

V _{dc} max	600 V	V _{acr}	230 V 1Ø
V _{dc} MPP	90 - 580 V	f _r	50 Hz
V _{dc} , Full Power	150 - 530 V	S _{max}	4600 VA
I _{dc} max	2 x 16 A	P _{acr} (cosφ = 1)	4600 W ⁽³⁾
I _{sc} max	2 x 20 A	P _{acr} (cosφ = 0.9)	4200 W ⁽³⁾
		A _{adj} cosφ	0.1 - 1 ⁽²⁾
		I _{sc} max	20 A

(1): @ 40°C amb. (2): Over/Under excited (3): 4200 W @ 45°C amb.

-25 to +60 °C
-13 to +140 °F

IP65    5 minutes



1 **ABB**   **4** Made in Italy

www.abb.com/solar SOLAR INVERTER **2** MODEL: UNO-DM-5.0-TL-PLUS-B

V _{dc} max	600 V	V _{acr}	230 V 1Ø
V _{dc} MPP	90 - 580 V	f _r	50 Hz
V _{dc} , Full Power	145 - 530 V	S _{max}	5000 VA
I _{dc} max	2 x 19 A	P _{acr} (cosφ = 1)	5000 W ⁽¹⁾
I _{sc} max	2 x 22 A	P _{acr} (cosφ = 0.9)	4500 W ⁽¹⁾
		A _{adj} cosφ	0.1 - 1 ⁽²⁾
		I _{sc} max	22 A

(1): @ 45°C amb. (2): Over/Under excited

-25 to +60 °C
-13 to +140 °F

IP65    5 minutes

Besides the Regulatory label, an additional product label is also provided. The label displays the following information:

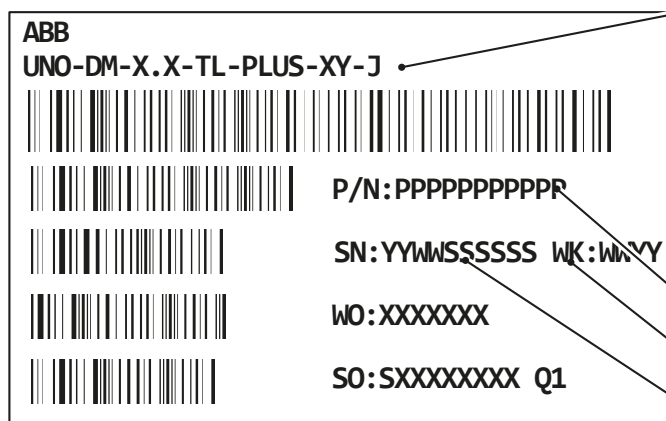

- **Inverter model**
 - X.X = Inverter power rating:
 - X = Integrated disconnect switch (-S)
 - Y = Integrated WLAN board (-B) or WLAN board and Accessory Board equipped with Ethernet board (-E)
 - J = Integrated Accessory Board (-X)
- **Inverter Part Number**
- **Week/Year of manufacture**
- **Inverter Serial Number consisting of:**
 - YY = Year of manufacture
 - WW = Week of manufacture
 - SSSSSS = sequential number



An additional Wireless Identification label is provided. The label displays the following information:

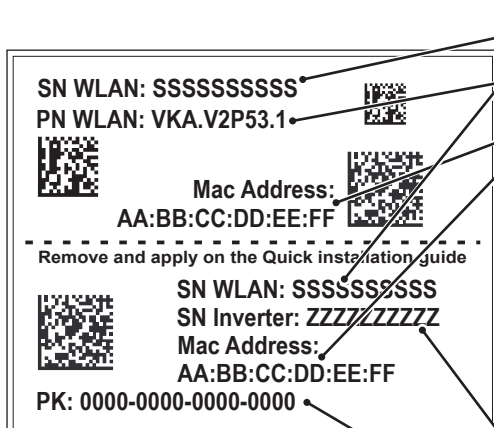

- **WLAN board Serial Number**
- **WLAN Board Part Number**
- **WLAN Board MAC address:**
 - To be used to obtain the SSID of the wireless access point created by the inverter: **ABB-XX-XX-XX-XX-XX-XX** (where "X" is a hex digit of the MAC address).
 - To be used to obtain the "Host Name": **http://ABB-XX-XX-XX-XX-XX-XX.local** (where "X" is a hex digit of the MAC address).
 - MAC address it's the only required information to register the inverter with Aurora Vision.
- **Inverter Serial Number**
- **Product Key:**
 To be used as the password of the wireless network generated by the inverter (Access Point) or as a username and password to access the internal web server if the credentials have been lost



The Wireless Identification label is divided in two separate parts by a dashed line; take the bottom part and apply it on the cover page of the quick installation guide.



The officially required information is located on the Regulatory label. The product label or the Wireless Identification label are accessory labels which shows the information necessary for the identification and characterisation of the inverter by ABB.



Note: The labels are NOT to be hidden by foreign objects and parts (rags, boxes, equipment, etc.); they must be regularly cleaned and always kept in sight.

Characteristics and technical data

	UNO-DM-1.2	UNO-DM-2.0	UNO-DM-3.0
Input Side			
Absolute maximum DC input voltage (V _{max,abs})		600 V	
Start-up DC input voltage (V _{start})	120 V (adj. 100V...150V)	150 V (adj. 100...250 V)	150 V (adj. 100...250 V)
Operating DC input voltage range (V _{dcm} ...V _{dcm})	0.7 x V _{start} ...580 V (min 90 V)		
Rated DC input voltage (V _{dcr})	185 V	300 V	300 V
Rated DC input power (P _{dcr})	1500 W	2500 W	3300W
Number of independent MPPT	1		
Maximum DC input power for each MPPT (P _{MPPTmax})	1500W	2500 W	3300V
DC input voltage range with parallel configuration of MPPT at P _{acr}	100...530 V	210...530 V	320...530 V
DC power limitation with parallel configuration of MPPT	N/A		
DC power limitation for each MPPT with independent configuration of MPPT at P _{acr} , max unbalance example	N/A		
Maximum DC input current (I _{dcm})	10.0 A		
Maximum return current (AC side vs. DC side)	< 5 mA (In case of failure, limited by the external protection provided on the AC circuit)		
Maximum input short circuit current	12.5 A		
Number of DC inputs pairs	1		
DC connection type	Quick Fit PV Connector ⁽¹⁾		
Type of photovoltaic panels connectable in input according to the IEC 61730 standard	Class A		
Input protection			
Reverse polarity protection	Yes, from limited current source		
Input over voltage protection - varistor	Yes		
Photovoltaic array isolation control	According to local standard		
DC switch rating for each MPPT (version with DC switch)	25 A / 600 V		
Output Side			
AC Grid connection type	Single phase		
Rated AC power (P _{acr} @cosφ=1)	1200 W	2000 W	3000 W
Maximum AC output power (P _{acmax} @cosφ=1)	1200 W	2000 W	3000 W
Maximum apparent power (S _{max})	1200 VA	2000 VA	3000 VA
Rated AC grid voltage (V _{ac,r})	230 V		
AC voltage range	180...264 V ⁽³⁾		
Maximum AC output current (I _{ac,max})	5.5 A	10.0 A	14.5 A
Contributory fault current	10.0 A	12.0 A	16.0A
Rated output frequency (f _r)	50 Hz - 60Hz ⁽⁴⁾		
Output frequency range (f _{min} ...f _{max})	47...53 Hz / 57...63Hz ⁽⁴⁾		
Nominal power factor and adjustable range	> 0.995, adj. 0.1 - 1 (over/under excited)		
Total current harmonic distortion	< 3.5		
AC connection type	Female connector from panel		
Output protection			
Anti-islanding protection	According to local standard		
Maximum external AC overcurrent protection	10.0 A	16.0 A	16.0 A
Output overvoltage protection - varistor	2 (L - N / L - PE)		
Operating performance			
Maximum efficiency (η _{max})	94.80%	96.70%	96.70%
Weighted efficiency (EURO/CEC)	92.0% / -	95.0% / -	95.0% / -
Feed in power threshold	8.0 W		
Night consumption	< 0.4W		

	UNO-DM-1.2	UNO-DM-2.0	UNO-DM-3.0
Communication			
Embedded Communication Interface		Wireless ⁽⁶⁾	
Embedded Communication Protocol		ModBus TCP (SunSpec)	
Optional Communication protocol		ModBus RTU (SunSpec) , Aurora Protocol	
Commissioning tool		Web User Interface, Display, Aurora Manger Lite	
Firmware Update Capabilities		Locally and remotely	
Monitoring		Plant Portfolio Manager, Plant Viewer, Plant Viewer for Mobile ⁽⁷⁾	
Optional board UNO-DM-COM kit			
Optional communication interface	RS485 (use with meter for dynamic control of the network input), alarm relay / load manager, remote On / Off		
Optional communication protocol	ModBus RTU (SunSpec), protocol Aurora		
Optional board UNO-DM-PLUS Ethernet COM kit			
Optional communication interface	Ethernet, RS485 (use with meter for dynamic control of the network input), alarm relay / load manager, remote On / Off		
Optional communication protocol	ModBus TCP (SunSpec), ModBus RTU (SunSpec), Protocol Aurora		
Environmental			
Ambient temperature range	-25...+60°C / -13...140°F with derating above 50°C/122°F		
Relative humidity	0...100 % condensing		
Acoustic noise emission level	50 dBA @ 1 m ⁽¹⁰⁾		
Maximum operating altitude without derating	2000 m / 6560 ft		
Classification of the degree of environmental pollution by external environment	3		
Environmental category	External		
Physical			
Environmental protection rating	IP 65		
Cooling	Natural		
Dimension (H x W x D)	553mm x 418mm x 175mm / 21.8" x 16.5" x 6.9"		
Weight	15 kg / 33 lb		
Mounting system	Wall bracket		
Overvoltage category according to IEC 62109-1	II (DC input) III (AC output)		
Safety			
Isolation level	Transformerless		
Marking	CE, RCM		
Safety class	I		
Safety and EMC standard	IEC/EN 62109-1, IEC/EN 62109-2, AS/NZS 4777.2, EN 61000-6-1, EN 61000-6-2, EN 61000-6-3, EN 61000-6-4, EN 61000-3-2, EN 61000-3-3,		
Grid standard ⁽⁹⁾ (check your sales channel for availability)	CEI 0-21, DIN V VDE V 0126-1-1, VDE-AR-N 4105, G83/2, G59/3, RD 413, ITC-BT-40, AS/NZS 4777.2, IEC 61727, IEC 62116		



1. Refer to the document "String inverter – Product Manual appendix" available at www.abb.com/solarinverters to know the brand and the model of the quick fit connector.

2. For UK G83/2 grid standard, maximum output current limited to 16A up to a maximum output power of 3600W and maximum apparent power of 3600 VA.

3. The AC voltage range may vary depending on specific country grid standard

4. The Frequency range may vary depending on specific country grid standard. CE only for 50Hz.

5. As per IEEE 802.11 b/g/n standard

7. Plant Viewer for Mobile available remotely only, not for local commissioning

8. Pacr = 4200 W @ 45°C/113°F

9. Further grid standard will be added, please refer to ABB Solar page for further details.

10. @ Pure sine wave condition.

Note. Features not specifically listed in the present data sheet are not included in the product

	UNO-DM-3.3	UNO-DM-4.0
Input Side		
Absolute maximum DC input voltage ($V_{max,abs}$)	600 V	
Start-up DC input voltage (V_{start})	200 V (adj. 120...350 V)	
Operating DC input voltage range ($V_{dcmin}...V_{dcmax}$)	0.7 x V_{start} ...580 V (min 90 V)	
Rated DC input voltage (V_{dcr})	360 V	
Rated DC input power (P_{dcr})	3500 W	4250 W
Number of independent MPPT	2	
Maximum DC input power for each MPPT ($P_{MPPTmax}$)	2000 W	3000 W
DC input voltage range with parallel configuration of MPPT at P_{acr}	170...530 V	130...530 V
DC power limitation with parallel configuration of MPPT	Linear derating from Max to Null [$530V \leq V_{MPPT} \leq 580V$] 2000 W [$200V \leq V_{MPPT} \leq 530V$]	Linear derating from Max to Null [$530V \leq V_{MPPT} \leq 580V$] 3000 W [$190V \leq V_{MPPT} \leq 530V$]
DC power limitation for each MPPT with independent configuration of MPPT at P_{acr} , max unbalance example	the other channel: $P_{dcr-2000W}$ [$112V \leq V_{MPPT} \leq 530V$]	the other channel: $P_{dcr-3000W}$ [$90V \leq V_{MPPT} \leq 530V$]
Maximum DC input current (I_{dcmax}) / for each MPPT ($I_{MPPTmax}$)	20.0 A / 10.0 A	32.0 A / 16.0 A
Maximum return current (AC side vs. DC side)	< 5 mA (In case of failure, limited by the external protection provided on the AC circuit)	
Maximum input short circuit current / for each MPPT	12.5 A / 25.0 A	20.0 A / 40.0 A
Number of DC inputs pairs for each MPPT	1	
DC connection type	Quick Fit PV Connector ⁽¹⁾	
Type of photovoltaic panels connectable in input according to the IEC 61730 standard	Class A	
Input protection		
Reverse polarity protection	Yes, from limited current source	
Input over voltage protection for each MPPT - varistor	Yes	
Photovoltaic array isolation control	According to local standard	
DC switch rating for each MPPT (version with DC switch)	25 A / 600 V	
Output Side		
AC Grid connection type	Single phase	
Rated AC power ($P_{acr} @ \cos\phi=1$)	3300 W	4000 W
Maximum AC output power ($P_{acmax} @ \cos\phi=1$)	3300 W	4000 W ⁽²⁾
Maximum apparent power (S_{max})	3300 VA	4000 VA ⁽²⁾
Rated AC grid voltage ($V_{ac,r}$)	230 V	
AC voltage range	180...264 V ⁽³⁾	
Maximum AC output current ($I_{ac,max}$)	14.5 A	17.2 A ⁽²⁾
Contributory fault current	16.0 A	19.0 A
Rated output frequency (fr)	50 Hz - 60 Hz ⁽⁴⁾	
Output frequency range ($f_{min}...f_{max}$)	47...53 Hz / 57...63Hz ⁽⁴⁾	
Nominal power factor and adjustable range	> 0.995, adj. 0.1 - 1 (over/under excited)	
Total current harmonic distortion	< 3.5	
AC connection type	Female connector from panel	
Output protection		
Anti-islanding protection	According to local standard	
Maximum external AC overcurrent protection	20.0 A	25.0 A
Output overvoltage protection - varistor	2 (L - N / L - PE)	
Operating performance		
Maximum efficiency (η_{max})	97.0%	97.0%
Weighted efficiency (EURO/CEC)	96.5% / -	96.5% / -
Feed in power threshold	8.0 W	
Night consumption	< 0.4W	



	UNO-DM-3.3	UNO-DM-4.0
Communication		
Embedded Communication Interface		Wireless ⁽⁶⁾
Embedded Communication Protocol		ModBus TCP (SunSpec)
Optional Communication protocol		ModBus RTU (SunSpec) , Aurora Protocol
Commissioning tool		Web User Interface, Display, Aurora Manger Lite
Firmware Update Capabilities		Locally and remotely
Monitoring		Plant Portfolio Manager, Plant Viewer, Plant Viewer for Mobile ⁽⁷⁾
Optional board UNO-DM-COM kit		
Optional communication interface	RS485 (use with meter for dynamic control of the network input), alarm relay / load manager, remote On / Off	
Optional communication protocol	ModBus RTU (SunSpec), protocol Aurora	
Optional board UNO-DM-PLUS Ethernet COM kit		
Optional communication interface	Ethernet, RS485 (use with meter for dynamic control of the network input), alarm relay / load manager, remote On / Off	
Optional communication protocol	ModBus TCP (SunSpec), ModBus RTU (SunSpec), Protocol Aurora	
Environmental		
Ambient temperature range	-25...+60°C / -13...140°F with derating above 50°C/122°F	
Relative humidity	0...100 % condensing	
Acoustic noise emission level	50 dBA @ 1 m ⁽¹⁰⁾	
Maximum operating altitude without derating	2000 m / 6560 ft	
Classification of the degree of environmental pollution by external environment	3	
Environmental category	External	
Physical		
Environmental protection rating	IP 65	
Cooling	Natural	
Dimension (H x W x D)	553mm x 418mm x 175mm / 21.8" x 16.5" x 6.9"	
Weight	15 kg / 33 lb	
Mounting system	Wall bracket	
Overvoltage category according to IEC 62109-1	II (DC input) III (AC output)	
Safety		
Isolation level	Transformerless	
Marking	CE, RCM	
Safety class	I	
Safety and EMC standard	IEC/EN 62109-1, IEC/EN 62109-2, AS/NZS 4777.2, EN 61000-6-1, EN 61000-6-2, EN 61000-6-3, EN 61000-6-4, EN 61000-3-2, EN 61000-3-3	IEC/EN 62109-1, IEC/EN 62109-2, AS/NZS 4777.2, EN 61000-6-1, EN 61000-6-2, EN 61000-6-3, EN 61000-6-4, EN 61000-3-11, EN 61000-3-12
Grid standard ⁽⁹⁾ (check your sales channel for availability)	CEI 0-21, DIN V VDE V 0126-1-1, VDE-AR-N 4105, G83/2, G59/3, RD 413, ITC-BT-40, AS/NZS 4777.2, IEC 61727, IEC 62116	



1. Refer to the document "String inverter – Product Manual appendix" available at www.abb.com/solarinverters to know the brand and the model of the quick fit connector.

2. For UK G83/2 grid standard, maximum output current limited to 16A up to a maximum output power of 3600W and maximum apparent power of 3600 VA.

3. The AC voltage range may vary depending on specific country grid standard

4. The Frequency range may vary depending on specific country grid standard. CE only for 50Hz.

5. As per IEEE 802.11 b/g/n standard

7. Plant Viewer for Mobile available remotely only, not for local commissioning

8. Pacr = 4200 W @ 45°C/113°F

9. Further grid standard will be added, please refer to ABB Solar page for further details.

10. @ Pure sine wave condition.

Note. Features not specifically listed in the present data sheet are not included in the product

	UNO-DM-4.6	UNO-DM-5.0
Input Side		
Absolute maximum DC input voltage ($V_{max,abs}$)	600 V	
Start-up DC input voltage (V_{start})	200 V (adj. 120...350 V)	
Operating DC input voltage range ($V_{dcr,min}...V_{dcr,max}$)	0.7 x V_{start} ...580 V (min 90 V)	
Rated DC input voltage (V_{dcr})	360 V	
Rated DC input power (P_{dcr})	4750 W	5150 W
Number of independent MPPT	2	
Maximum DC input power for each MPPT (PMPPT-max)	3000 W	3500 W
DC input voltage range with parallel configuration of MPPT at P_{acr}	150...530 V	145...530 V
DC power limitation with parallel configuration of MPPT	Linear derating from Max to Null [$530V \leq V_{MPPT} \leq 580V$] 3000 W [$190V \leq V_{MPPT} \leq 530V$]	Linear derating from Max to Null [$530V \leq V_{MPPT} \leq 580V$] 3500 W [$200V \leq V_{MPPT} \leq 530V$]
DC power limitation for each MPPT with independent configuration of MPPT at P_{acr} , max unbalance example	the other channel: P_{dcr} -3000W [$90V \leq V_{MPPT} \leq 530V$]	the other channel: P_{dcr} -3500W [$90V \leq V_{MPPT} \leq 530V$]
Maximum DC input current ($I_{dcr,max}$) / for each MPPT (IMPPTmax)	32.0 A / 16.0 A	38.0 A / 19.0 A
Maximum return current (AC side vs. DC side)	< 5 mA (In case of failure, limited by the external protection provided on the AC circuit)	
Maximum input short circuit current / for each MPPT	20.0 A / 40.0 A	22.0 A / 44.0 A
Number of DC inputs pairs for each MPPT	1	
DC connection type	Quick Fit PV Connector ⁽¹⁾	
Type of photovoltaic panels connectable in input according to the IEC 61730 standard	Class A	
Input protection		
Reverse polarity protection	Yes, from limited current source	
Input over voltage protection for each MPPT - varistor	Yes	
Photovoltaic array isolation control	According to local standard	
DC switch rating for each MPPT (version with DC switch)	25 A / 600 V	
Output Side		
AC Grid connection type	Single phase	
Rated AC power (P_{acr} @ $\cos\phi=1$)	4600 W	5000 W
Maximum AC output power ($P_{acr,max}$ @ $\cos\phi=1$)	4600 W	5000 W
Maximum apparent power (S_{max})	4600 VA	5000 VA
Rated AC grid voltage ($V_{ac,r}$)	230 V	
AC voltage range	180...264 V ⁽³⁾	
Maximum AC output current ($I_{ac,max}$)	20.0 A	22.0 A
Contributory fault current	22.0 A	24.0 A
Rated output frequency (fr)	50 Hz - 60 Hz ⁽⁴⁾	
Output frequency range ($f_{min}...f_{max}$)	47...53 Hz / 57...63Hz ⁽⁴⁾	
Nominal power factor and adjustable range	> 0.995, adj. 0.1 - 1 (over/under excited)	
Total current harmonic distortion	< 3.5	
AC connection type	Female connector from panel	
Output protection		
Anti-islanding protection	According to local standard	
Maximum external AC overcurrent protection	25.0 A	32.0 A
Output overvoltage protection - varistor	2 (L - N / L - PE)	
Operating performance		
Maximum efficiency (η_{max})	97.0%	97.40%
Weighted efficiency (EURO/CEC)	96.5% / -	97.0% / -
Feed in power threshold	8.0 W	
Night consumption	< 0.4W	



	UNO-DM-4.6	UNO-DM-5.0
Communication		
Embedded Communication Interface		Wireless ⁽⁵⁾
Embedded Communication Protocol		ModBus TCP (SunSpec)
Optional Communication protocol		ModBus RTU (SunSpec) , Aurora Protocol
Commissioning tool		Web User Interface, Display, Aurora Manger Lite
Firmware Update Capabilities		Locally and remotely
Monitoring		Plant Portfolio Manager, Plant Viewer, Plant Viewer for Mobile ⁽⁷⁾
Optional board UNO-DM-COM kit		
Optional communication interface	RS485 (use with meter for dynamic control of the network input), alarm relay / load manager, remote On / Off	
Optional communication protocol	ModBus RTU (SunSpec), protocol Aurora	
Optional board UNO-DM-PLUS Ethernet COM kit		
Optional communication interface	Ethernet, RS485 (use with meter for dynamic control of the network input), alarm relay / load manager, remote On / Off	
Optional communication protocol	ModBus TCP (SunSpec), ModBus RTU (SunSpec), Protocol Aurora	
Environmental		
Ambient temperature range	-25...+60°C /-13... 140°F with derating above 40°C/104°F ⁽⁸⁾	-25...+60°C /-13...+ 140°F with derating above 45°C/113°F
Relative humidity	0...100 % condensing	
Acoustic noise emission level	50 dBA @ 1 m ⁽¹⁰⁾	
Maximum operating altitude without derating	2000 m / 6560 ft	
Classification of the degree of environmental pollution by external environment	3	
Environmental category	External	
Physical		
Environmental protection rating	IP 65	
Cooling	Natural	
Dimension (H x W x D)	553mm x 418mm x 175mm / 21.8" x 16.5" x 6.9"	
Weight	15 kg / 33 lb	
Mounting system	Wall bracket	
Overvoltage category according to IEC 62109-1	II (DC input)	III (AC output)
Safety		
Isolation level	Transformerless	
Marking	CE, RCM	
Safety class	I	
Safety and EMC standard	IEC/EN 62109-1, IEC/EN 62109-2, AS/NZS 4777.2, EN 61000-6-1, EN 61000-6-2, EN 61000-6-3, EN 61000-6-4, EN 61000-3-11, EN 61000-3-12	
Grid standard ⁽⁹⁾ (check your sales channel for availability)	CEI 0-21, DIN V VDE V 0126-1-1, VDE-AR-N 4105, G59/3, RD 413, ITC-BT-40, AS/NZS 4777.2, IEC 61727, IEC 62116	CEI 0-21, DIN V VDE V 0126-1-1, VDE-AR-N 4105, G59/3, RD 413, ITC-BT-40, AS/NZS 4777.2, C10/11, IEC 61727, IEC 62116



1. Refer to the document "String inverter – Product Manual appendix" available at www.abb.com/solarinverters to know the brand and the model of the quick fit connector.
2. For UK G83/2 grid standard, maximum output current limited to 16A up to a maximum output power of 3600W and maximum apparent power of 3600 VA.
3. The AC voltage range may vary depending on specific country grid standard
4. The Frequency range may vary depending on specific country grid standard. CE only for 50Hz.
5. As per IEEE 802.11 b/g/n standard
7. Plant Viewer for Mobile available remotely only, not for local commissioning
8. Pacr = 4200 W @ 45°C/113°F
9. Further grid standard will be added, please refer to ABB Solar page for further details.
10. @ Pure sine wave condition.

Note. Features not specifically listed in the present data sheet are not included in the product

Tightening torques

To maintain the IP65 protection of the system and for optimal installation, the following tightening torques must be used:

AC output connector cable gland ⑩ (ring nut fastening)	4...5 Nm
Screws for securing AC output connector cables gland	0.8...1 Nm
Service cable gland ⑳ M25 (ring nut fastening)	5.0 Nm
Service cable gland ⑳ M25 (lock nut fastening)	7.5 Nm
Front cover fastening screws ①⑤	2.5 Nm
Screw for external ground connection ⑱	2.5 Nm

Overall dimensions

The overall dimensions are expressed in millimetres and inches and include the wall installation bracket.

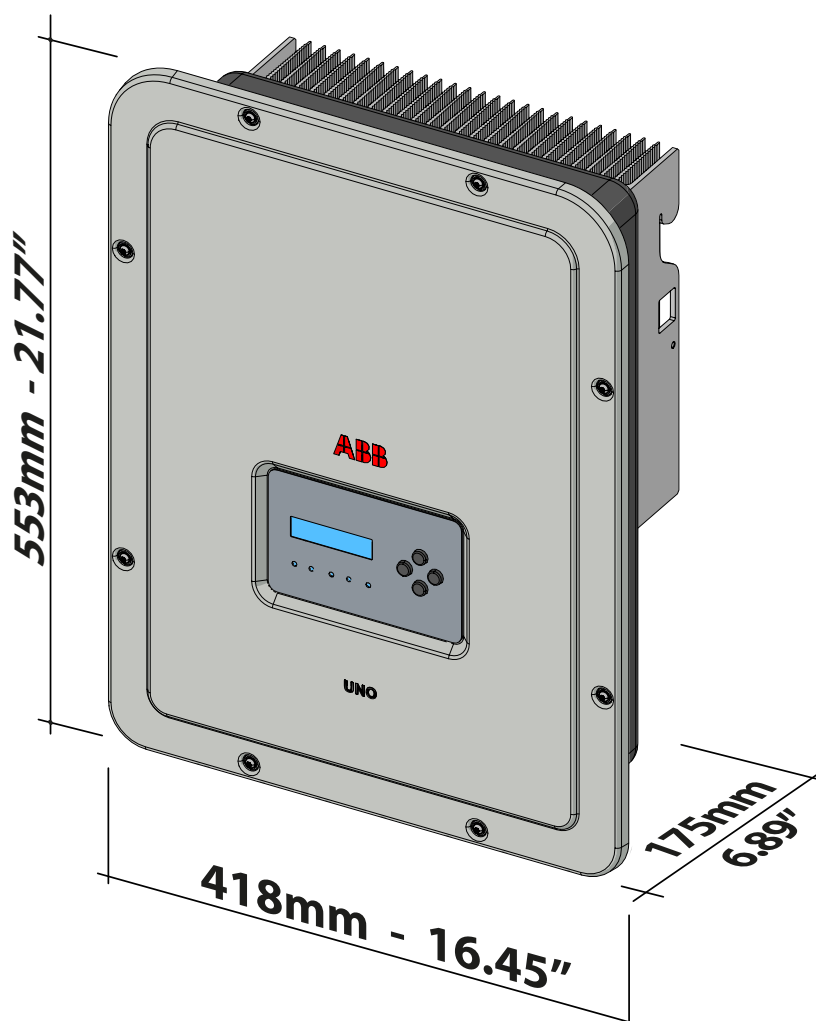

Bracket dimensions

The dimensions of the wall mounting bracket are expressed in mm.

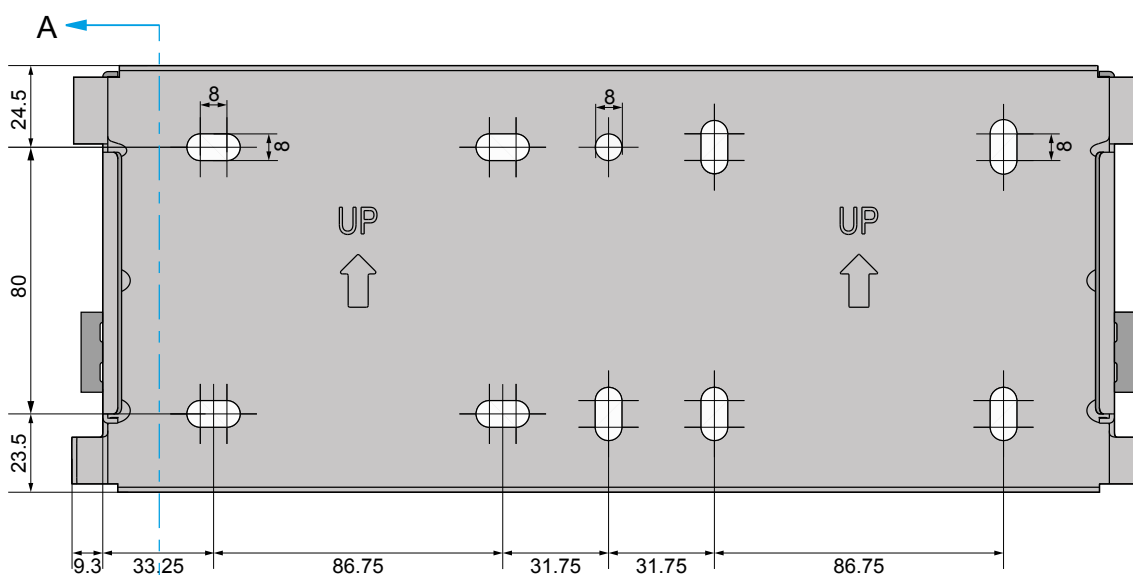
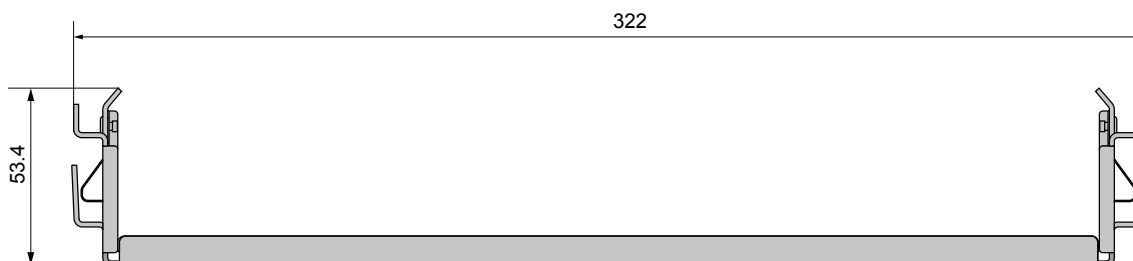

A ←

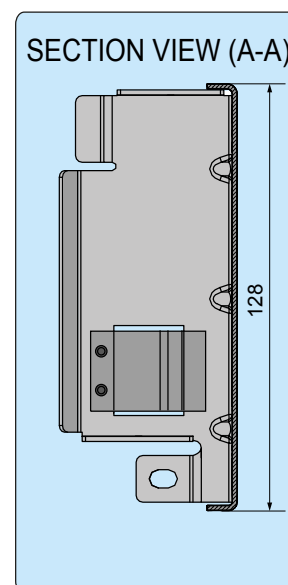
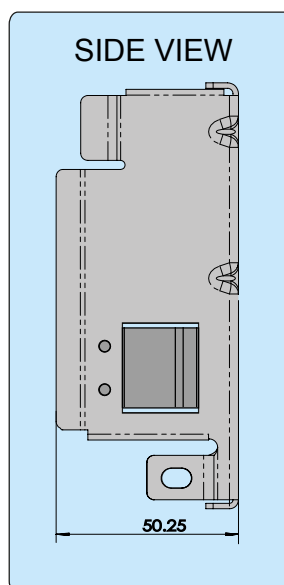
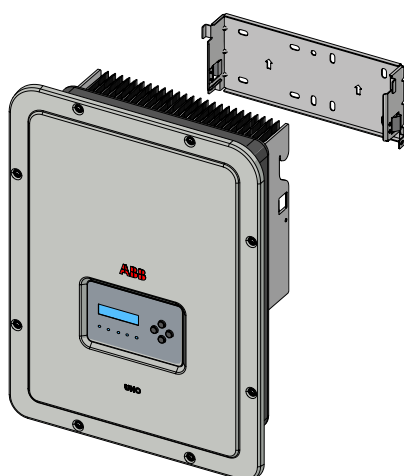

Curve di efficienza

L'apparecchiatura è stata progettata considerando le norme vigenti sul risparmio energetico, evitando sprechi e inutili dispersioni.

Di seguito sono riportati i grafici con le curve di efficienza di tutti i modelli di inverter descritti nel presente manuale.



Le curve di efficienza sono legate a parametri tecnici in continua evoluzione e perfezionamento e sono di conseguenza da intendersi come indicative.

UNO-DM-3.3-TL-PLUS - Efficiency Curves

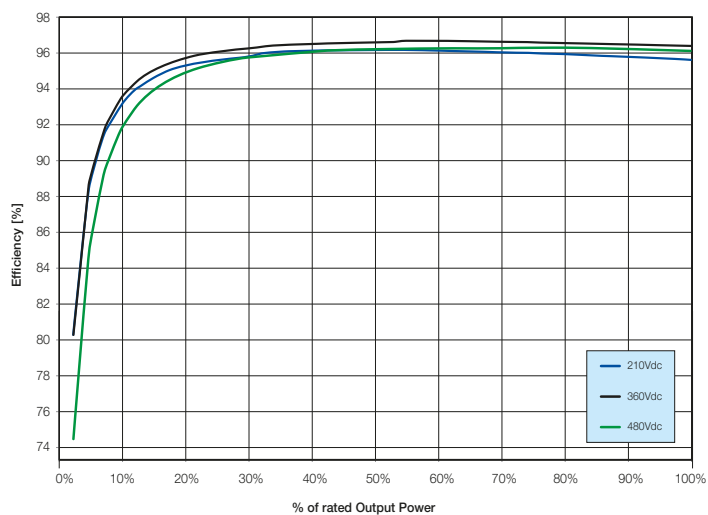

UNO-DM-4.0-TL-PLUS - Efficiency Curves

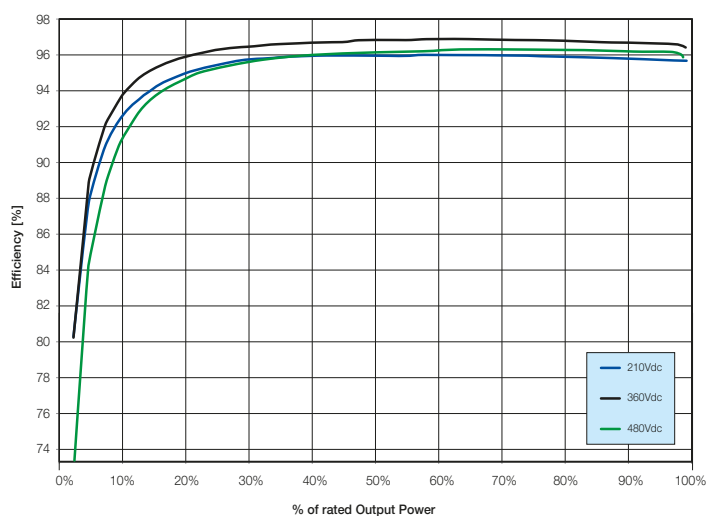

UNO-DM-4.6-TL-PLUS - Efficiency Curves

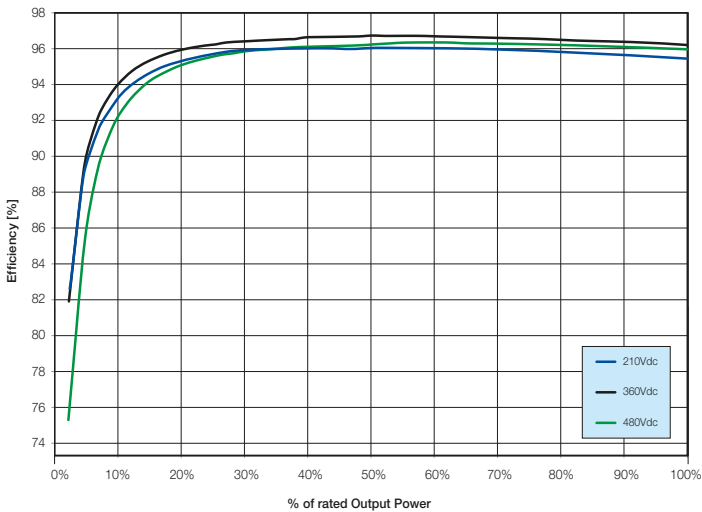

UNO-DM-5.0-TL-PLUS - Efficiency Curves

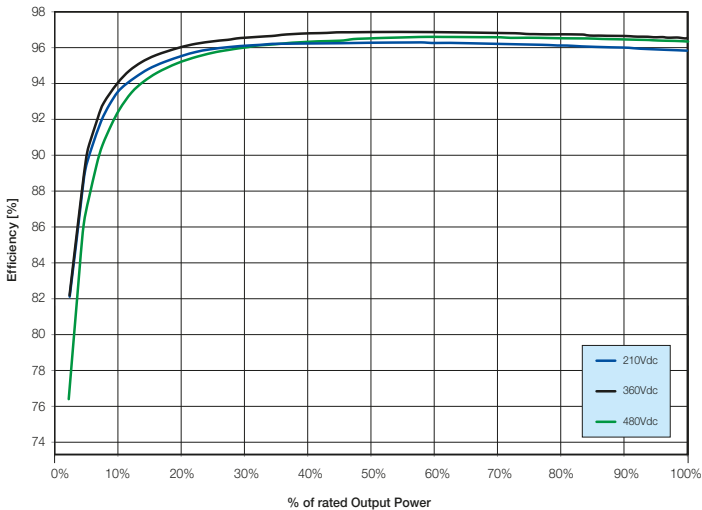

Limitazione di potenza (Power Derating)

Al fine di consentire il funzionamento dell'inverter in condizioni di sicurezza sia termica che elettrica, l'unità provvede in modo automatico a ridurre il valore della potenza immessa in rete.

La limitazione di potenza può avvenire per:

- Condizioni ambientali avverse (derating termico)
- Valore percentuale della potenza di uscita (valore impostato dall'utente)
- Sovrafrequenza della tensione di rete (modalità impostata dall'utente)
- Sovratensione di rete $U > 10\text{min Der.}$ (abilitazione effettuata dall'utente)
- Anti-islanding
- Valori della tensione di ingresso elevati
- Valori della corrente di ingresso elevati.



Riduzione di potenza dovuta alle condizioni ambientali

Il valore di riduzione di potenza e la temperatura dell'inverter alla quale essa si verifica dipendono dalla temperatura ambiente e da numerosi parametri di funzionamento. Esempio: tensione di ingresso, tensione di rete e potenza disponibile dal campo fotovoltaico.

Pertanto l'inverter potrà ridurre la potenza durante certi periodi della giornata a seconda del valore di tali parametri.

Comunque, l'inverter garantisce la massima potenza di uscita anche a temperature elevate, purché non sia investito direttamente dal sole.

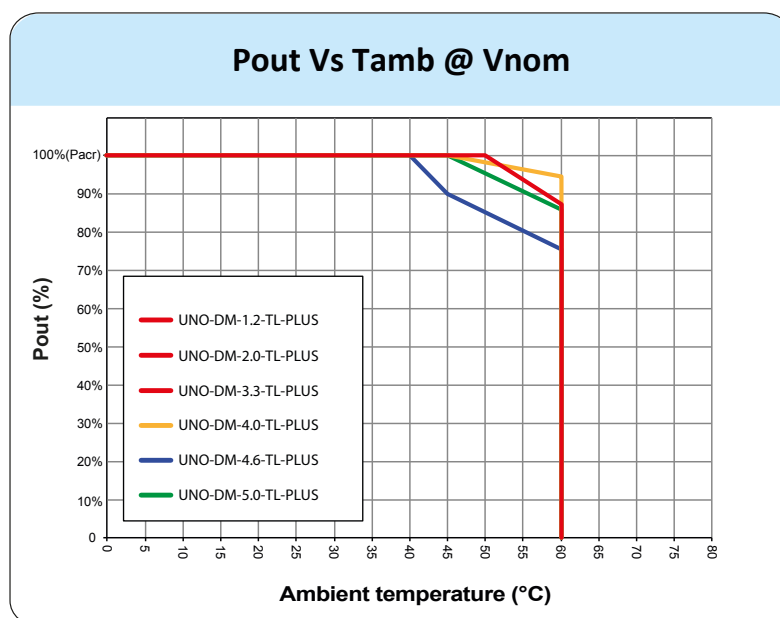

Riduzione di potenza dovuta alla tensione in ingresso

I grafici mostrano la riduzione automatica della potenza erogata in corrispondenza di valori della tensione in ingresso troppo alti o troppo bassi.

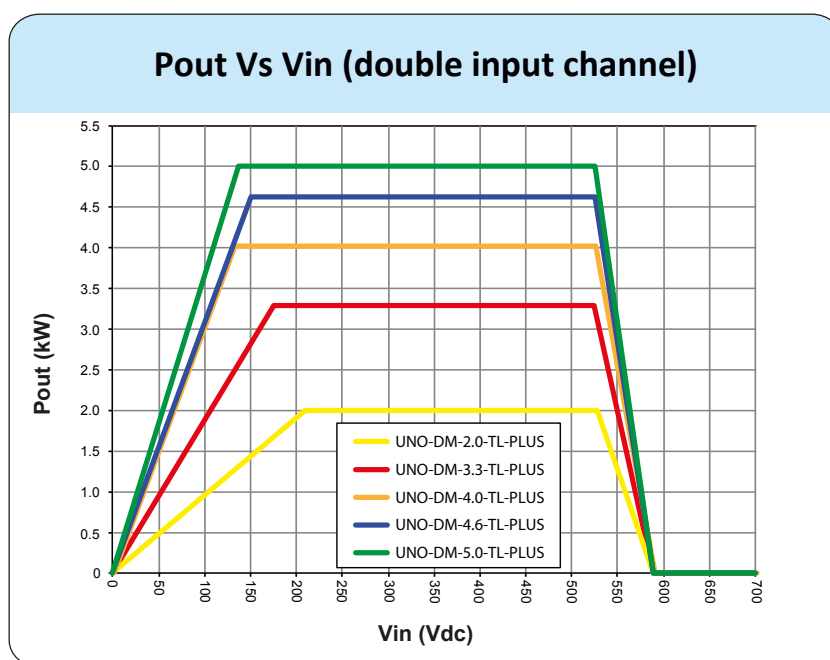

Characteristics of a photovoltaic generator

A PV electric system consists of an assembly of photovoltaic modules that transform solar radiation into DC electrical energy and can be made up of:

Strings: number (X) of PV modules connected in series

Array: group of X strings connected in parallel



Strings and arrays

The string technology was developed to significantly reduce the installation costs of a photovoltaic system, mainly associated to wiring on the DC side of the inverter and subsequent distribution on the AC side. A photovoltaic module consists of many photovoltaic cells mounted on the same support.

- A string consists of a certain number of module connected in series.
- An array consists of two or more strings connected in parallel.

Large photovoltaic systems can include multiple arrays connected to one or more inverters.

The greater the number of panels in each string, the lower the cost and the less complex the wiring connections of the system.

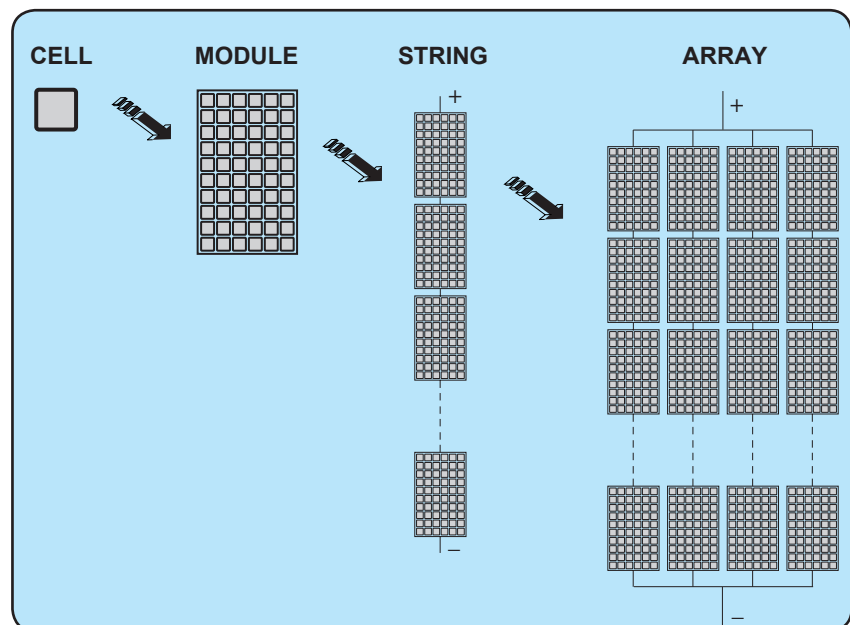

Description of the equipment

This equipment is a string inverter which converts the direct current of a photovoltaic generator into alternating current and feeds it into the public distribution grid.

Photovoltaic panels convert solar radiation into “DC” electrical energy (via a photovoltaic field, also called PV generator); in order to use it, it is transformed into “AC” alternating current. This conversion, known as inversion from DC to AC, is done in an efficient way by the ABB inverters, without using any rotary elements, rather only via static electronic systems.

In order to allow inverter operation in safe thermal and electrical conditions, the unit automatically reduces the value of the power fed into the grid under adverse environmental conditions or unsuitable input voltage values.

When connected in parallel with the grid, the alternating current from the inverter flows directly into the domestic or industrial distribution circuit, which is in turn connected to the public distribution grid.

This way the solar energy system compensates for the energy drawn from the utilities connected to the grid to which it is linked.

When the photovoltaic system is not generating sufficient energy, the power required to ensure proper operation of connected loads is taken from the public distribution grid. While if too much energy is produced, it is directly fed to the grid, thus becoming available to other users.

According to national and local standards and regulations the produced energy can be sold to the grid or credited to the user against future consumption, thus granting a great saving of money.



Operating diagram

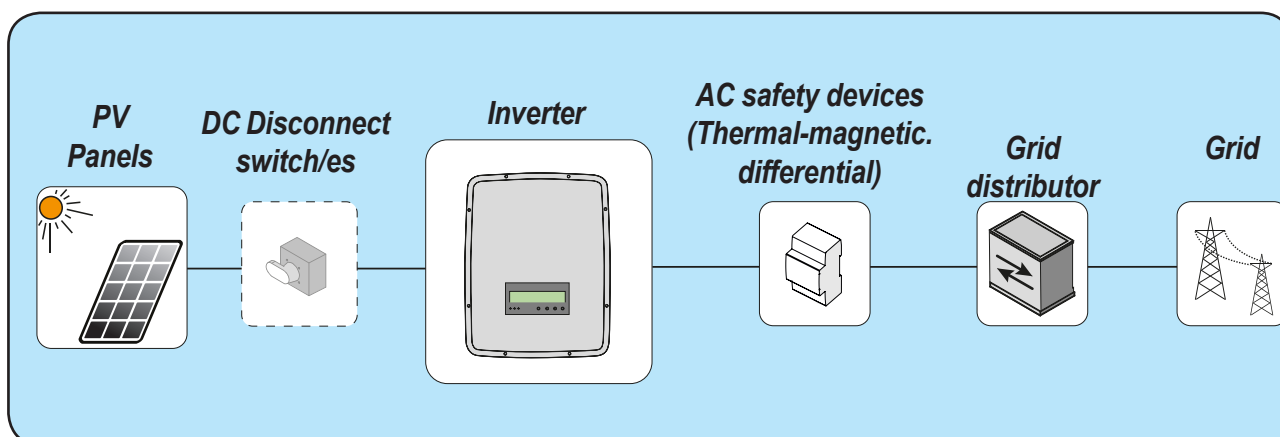

Mutual connection of multiple inverters

If the photovoltaic system exceeds the capacity of a single inverter, it is possible to connect multiple inverters to the system, each of them in turn connected on the DC side to an appropriate section of the photovoltaic generator, and on the AC side to the distribution grid.

Each string inverter will work independently of the others and its own photovoltaic module will supply the maximum power available to the grid.



Notes on the system sizing

Decisions on how to structure a photovoltaic system depend on a series of factors and considerations, such as the type of panels, the space availability, the future location of the system, energy production goals over the long term, etc.

A configuration program that can help to correctly size the photovoltaic system is available on the ABB website (<http://stringsizer.abb.com>).

Operating diagram

The plant diagram shows how the integrated WLAN board allows the inverter to connect to a LAN local network using a wireless connection. The WLAN board features an advanced integrated webserver that enables to establish a direct connection to a PC, smartphone or tablet, allowing for inverter setup and local monitoring of the inverter.

When the inverter is connected to the WLAN network with access to the Internet, the device allows data to be transferred to the Aurora Vision® CLOUD platform for Internet monitoring using the Plant Portfolio Manager / Plant Viewer / Plant Viewer for Mobile (Mobile App).

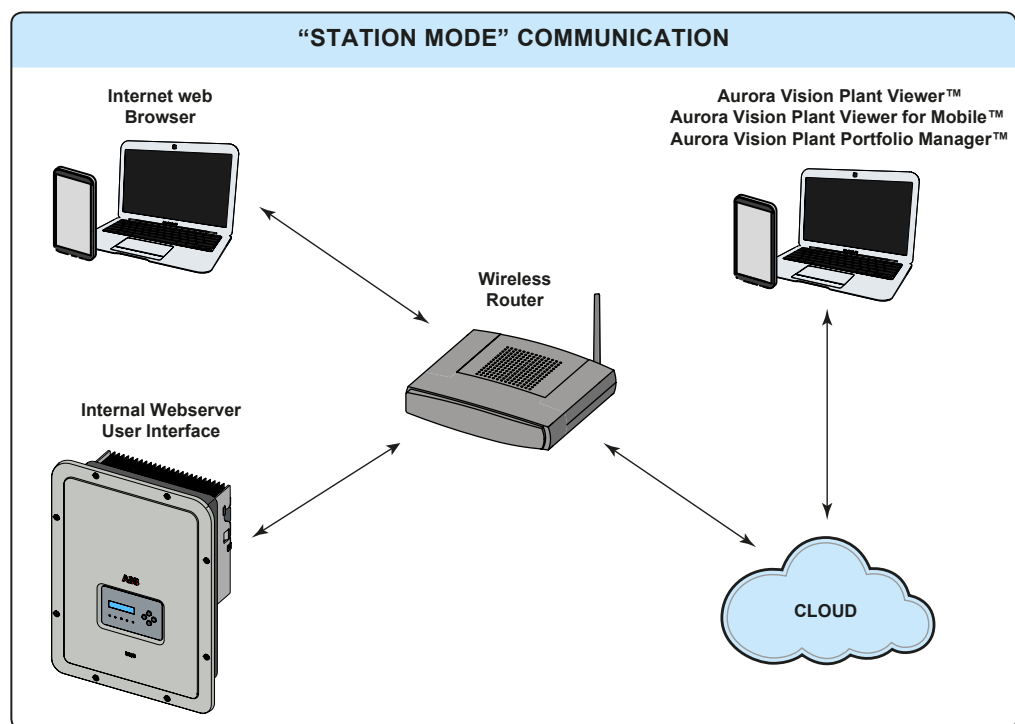
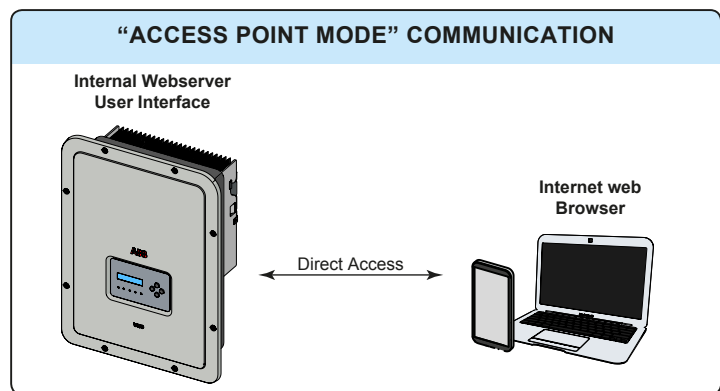

Functionality and components of the equipment

Advanced internal webserver

The UNO-DM-TL-PLUS inverters are equipped with a WLAN board IEEE802.11 b/g/n and with an internal webserver that allow commissioning of the system, a full access to all main configuration and parameters of the inverter and can act as local monitoring solution. It can be accessed by using from any wireless capable device like laptop, tablet or smartphone via a common browser.

Aurora Vision Plant Management Platform

Aurora Vision is a cloud based platform enabling remote monitoring and asset management of ABB devices in range of solar power application.

Aurora Vision consists of a three different product:

1. **Plant Portfolio Manager** is a full featured web based application used by solar power professionals to monitor and manage a portfolio of solar power plants using ABB inverters.
2. **Plant Viewer** is an easy to use web based serviced application used by non-solar power professionals (such as homeowners or small business owners) to monitor solar power plants they own.
3. **Plant Viewer for Mobile** is the mobile version of **Plant Viewer** enabling non-solar power professionals to remotely monitor their own PV plants by using smart phones, tablets and iPod Touch with IOS and Android operating systems.

All three product previously mentioned work together to allow solar power professional and site owners to collaboratively manage solar power plant.

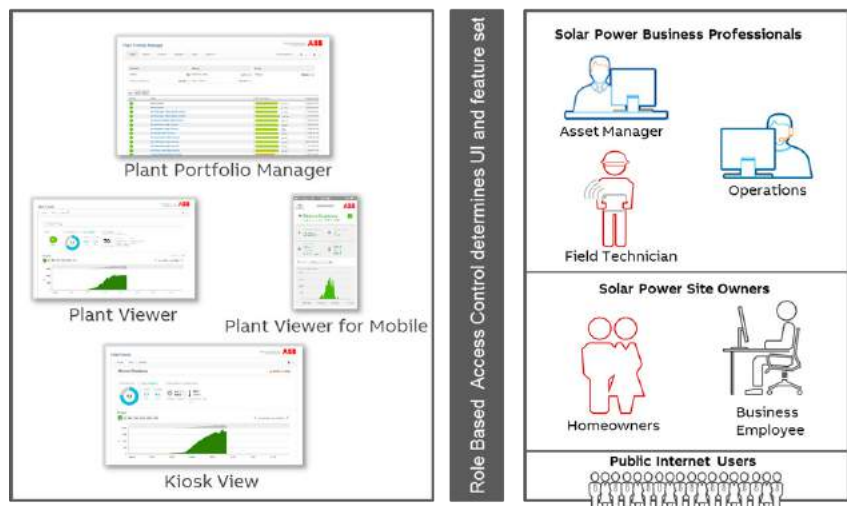

Please contact the ABB technical support for getting your own plant portfolio manager account (mainly for installers and plant administrators). Please get your Plant Viewer and Plant Viewer for Mobile by accessing the website www.auroravision.net and click on “Register with Plant Viewer” button (mainly for site owners).



System integration

The inverter also can be equipped with advanced accessory board (UNO-DM-COM KIT or UNO-DM-PLUS-COM Ethernet KIT) adding either an RS-485 serial interface or the Ethernet communication interface enabling the inverter to be used in one of the following operating mode:

- Dyamic feed-in control / Load Management (meter required):

In combination with the supported meter (connected to RS485 communication port) the inverter automatically adapt the output power in order to get self-consumption to be maximise or avoiding to feed power to the grid according to the system settings.

In addition, the advanced accessory board (UNO-DM-COM KIT or UNO-DM-PLUS-COM Ethernet KIT) is equipped with a configurable switching relay which can be used for manage external loads with customizable activation power and temporal thresholds (basic load management capability).

- Modbus Sunspec certified interface:

Thanks to the Modbus RTU/TCP communication protocol (Sunspec compliant), the inverter can be easily integrated with third party monitoring and control system by using the accessory board (UNO-DM-COM KIT or UNO-DM-PLUS-COM Ethernet KIT).



The Modbus RTU/TCP register map is the same for all the communication interfaces (Ethernet, RS-485 and Wi-Fi) of the inverter.

Please refer to ABB solar official website or get access to Sunspec alliance website for getting the Modbus register map supported by the inverter.

- Configurable relay:

The inverter also can be equipped with advanced accessory board (UNO-DM-COM KIT or UNO-DM-PLUS-COM Ethernet KIT) that provides a configurable switching relay, which can be used in different operating configurations that can be set in the dedicated menu.

A typical example of application is the activation of the relay in the event of an alarm.

Remote switch-on/switch-off

This command can be used to switch off/switch on the inverter via an external (remote) command.

This function must be enabled in the menu and when active, switching on the inverter, besides being dictated by the presence of normal parameters which allow the inverter to be connected to the grid, also depends on the external command for switching on/off.

Remote Firmware Update Function

The inverter firmware can be updated remotely using the internal web-server dedicated section.

Reactive power feed into the grid

The inverter is able to produce reactive power and can feed this power into the grid via the phase factor setting. Managing the feed can be controlled directly by the grid company via a dedicated RS485 serial interface or set by the display or through the configuration software, Aurora Manager Lite.

Power feeding modes vary according to the country of installation and the grid companies. For detailed information on the parameters and characteristics of this function, contact **ABB** directly.

Limiting the active power fed into the grid

The inverter, if enabled and set using the display or the Aurora Manager configuration software, can limit the amount of active power fed into the grid by the inverter to the desired value (expressed as a percentage).



Topographic diagram of the equipment

The diagram summarises the internal structure of the inverter.

The internal circuitry is double stage conversion and therefore consists of:

- DC/DC input converter (booster)
- DC-AC output inverter

The DC-DC converter and the DC-AC inverter both work at a high switching frequency and are therefore small and relatively light.

The input converter is equipped;

- in models 1.2 / 2.0 / 3.0 of an input channel
- in models 3.3 / 4.6 / 5.0 two input channels with maximum power point tracking function (MPPT).



This inverter version is of the transformerless type, that is without galvanic insulation between the input and the output. This allows the conversion efficiency to be increased further. The inverter is already equipped with all the protections necessary for safe operation and compliance with standards and regulations, even without the insulating transformer.

The connection to the power grid is therefore kept under control by two independent processors, in full compliance with the electric field regulations both for power supply to the systems as well as security.

The operating system carries out the task of communicating with its components in order to carry out data analysis.

In doing all this, we guarantee optimal operation of the whole assembly and a high performance in all sunlight conditions and always ensuring full compliance with the relevant directives, standards and regulations.

Block diagram of UNO-DM-1.2/2.0-TL-PLUS

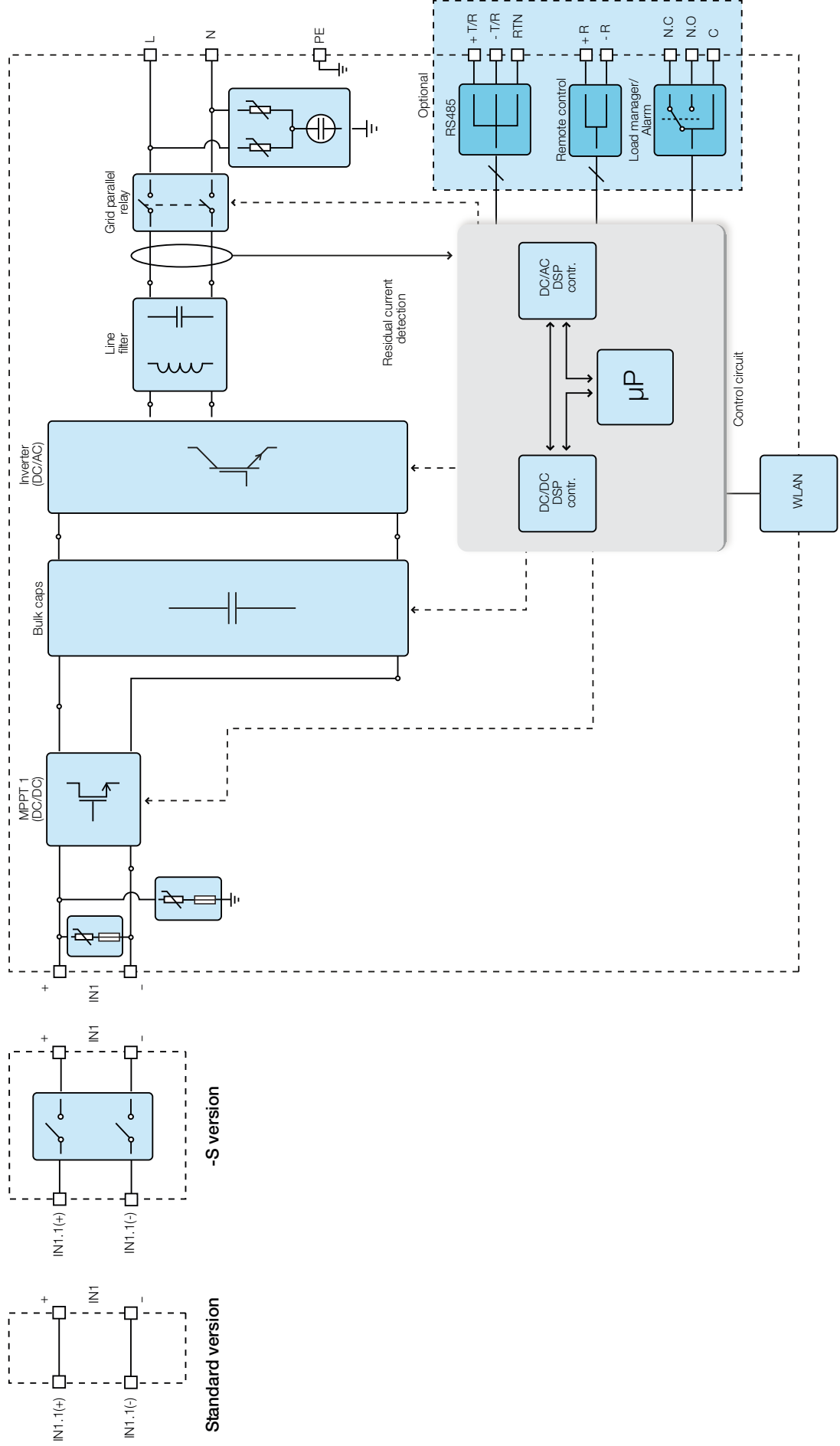

000683BG

Block diagram of UNO-DM-3.3/4.0/4.6/5.0-TL-PLUS

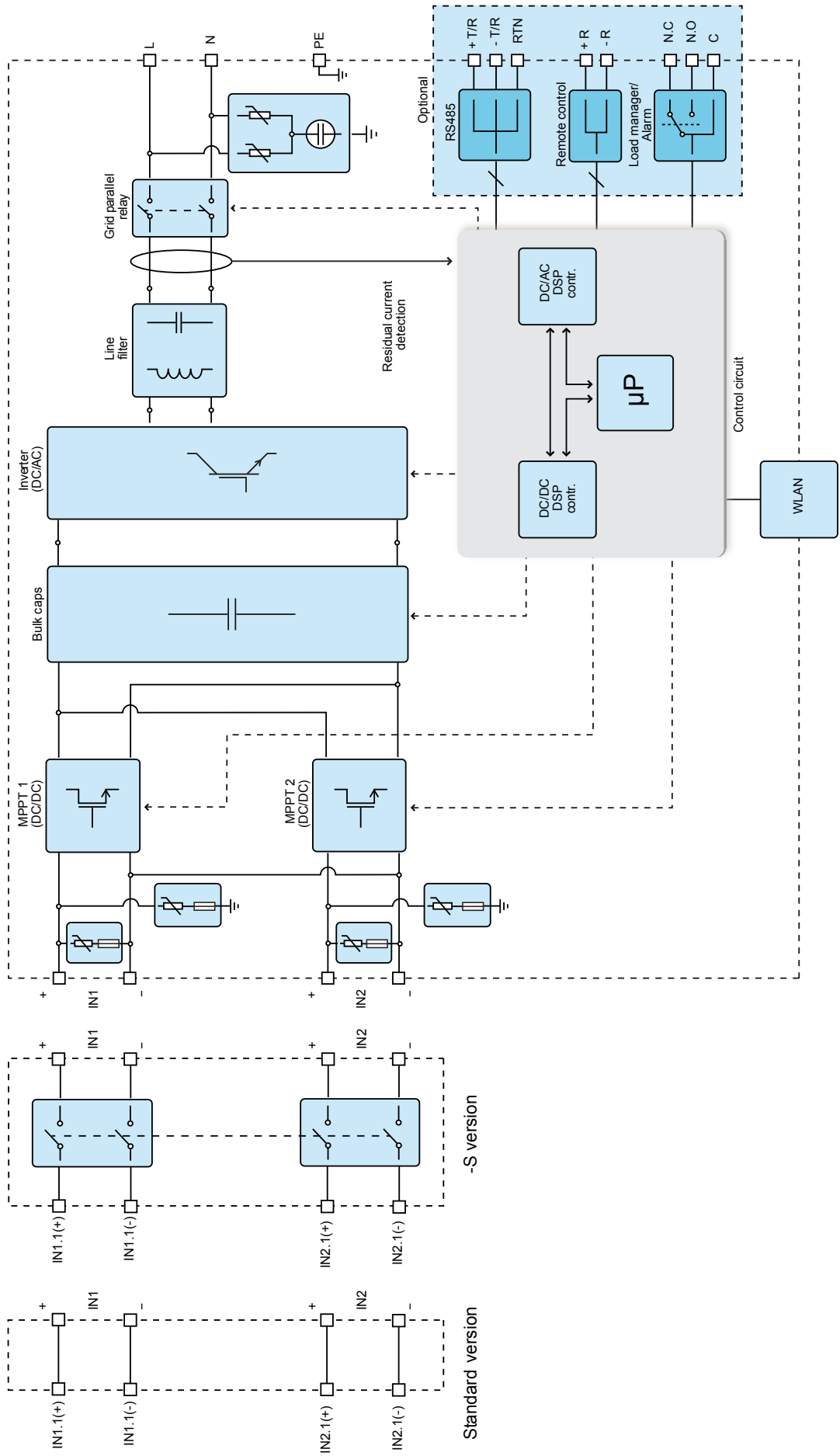

Safety devices

Anti-Islanding

In the event of a local grid outage by the electricity company, or when the equipment is switched off for maintenance operations, the inverter must be physically disconnected to ensure the protection of the people working on the grid, in accordance with the relevant national laws and regulations. To prevent possible islanding, the inverter is equipped with an automatic safety disconnection system called "Anti-Islanding".

Anti-islanding protection mechanisms are different depending on the grid standards, even if they all have the same purpose.

Ground fault of the photovoltaic panels

This inverter must be used with panels connected in "floating" mode, i.e. with no earth connections on the positive and negative terminals. An advanced ground fault protection circuit continuously monitors the ground connection and disconnects the inverter when a ground fault indicating the fault condition by means of the red "GFI" LED on the LED panel on the front side.

Other safety devices

The inverter is equipped with additional protective devices to ensure safe operation in any circumstance. These protections include:

- Constant monitoring of the grid voltage to ensure that voltage and frequency values remain within operating limits;
- Internal temperature control to automatically limit the power if necessary to prevent overheating of the unit (derating).

The numerous control systems determine a redundant structure to ensure absolutely safe operations.

Safety information and instructions

The equipment has been manufactured in accordance with the strictest accident-prevention regulations and supplied with safety devices suitable for the protection of components and operators.



For obvious reasons, it is not possible to anticipate the great number of installations and environments in which the equipment will be installed. It is therefore necessary for the customer to appropriately inform the manufacturer about particular installation conditions.

ABB accepts no liability for failure to comply with the instructions for correct installation and cannot be held responsible for the upstream or downstream equipment.



It is essential to provide operators with correct information. They must therefore read and comply with the technical information provided in the manual and in the attached documentation.

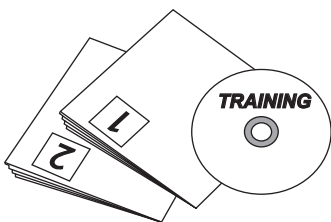

The instructions provided in the manual do not replace the safety devices and technical data for installation and operation labels on the product, and they do not replace the safety regulations in force in the country of installation.

The manufacturer is willing to train staff, at its premises or on site, in accordance with conditions agreed to in the contract.



Do not use the equipment if you find any operating anomalies.

Avoid temporary repairs. All repairs should be carried out using only genuine spare parts, which must be installed in accordance with their intended use.

Liabilities arising from commercial components are delegated to the respective manufacturers.

Hazardous areas and operations

Environmental conditions and risks

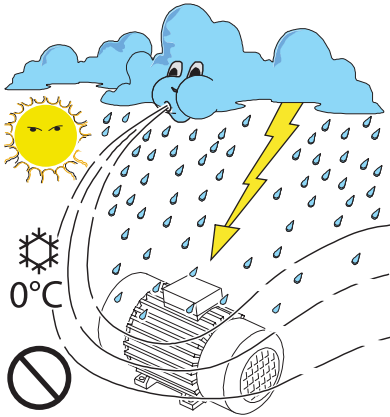

The device can be installed outdoors, but only in environmental conditions that do not prevent its regular operation. These conditions are listed in the technical data and in the installation chapter.

ABB IS NOT responsible for the disposal of the equipment: displays, cables, batteries, accumulators, etc., and therefore the customer must dispose of these items, which are potentially harmful to the environment, in accordance with the regulations in force in the country of installation.

The same precautions shall be adopted for dismantling the equipment.



The device is not designed to operate in environments that are particularly inflammable or explosive.

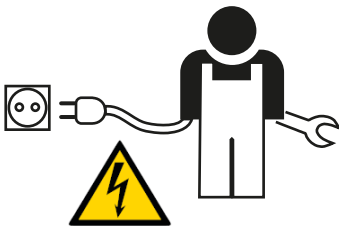

The customer and/or installer must appropriately train operators or anyone who may come into close proximity of the equipment, and highlight, with notices or other means where necessary, the hazardous areas or operations at risk: magnetic fields, hazardous voltages, high temperatures, possible discharges, generic hazard, etc.

Signs and labels



The labels affixed on the equipment must strictly NOT be removed, damaged, defaced, hidden, etc.

The labels must be regularly cleaned and kept in sight, i.e. NOT hidden by foreign objects and parts (rags, boxes, equipment, etc.)

The technical data provided in this manual does not in any case replace that shown on the labels affixed on the equipment.

Thermal and electrical hazard

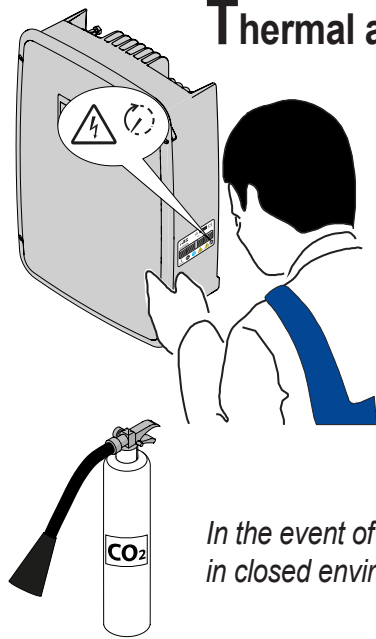

WARNING: the removal of guards or covers is only permitted after the voltage has been removed and time period indicated on the label has passed. This is to let the components cool down and allow the internal capacitors to discharge.

When the device has just been switched off, it may have hot parts as a result of overheating of the heated surfaces (e.g.: transformers, accumulators, coils, etc.) so be careful where you touch.

In the event of fire, use CO2 extinguishers and auto-extraction systems to extinguish the fire in closed environments.



Clothing and protection of personnel

ABB has done its best to eliminate sharp edges and corners, but as this is not always possible you are advised always to wear the clothing and personal protective equipment provided by the employer.



Personnel must not wear clothes or accessories that could start fires or generate electrostatic charges or, in general, clothing that can compromise personal safety.



All operations on the equipment must be performed with adequately insulated clothing and instruments.

E.g.: insulating gloves, class 0, RC category

Maintenance operations may only be performed after the equipment has been disconnected from the grid and from the photovoltaic generator.

Staff must NOT go near the equipment with bare feet or wet hands.

The maintenance technician must in any case ensure that no one else can switch on or operate the device during the maintenance operations, and should report any anomaly or damage due to wear or ageing so that the correct safety conditions can be restored.

The installer or maintenance technician must always pay attention to the work environment, ensuring that it is well-lit and there is enough room to ensure an escape route.



During installation, **consider that the noise emitted based on the environment** could possibly exceed the legal thresholds (less than 80 dBA), therefore, suitable ear protection must be worn.

Residual risks



Despite the warnings and safety systems, there are still some residual risks that cannot be eliminated.

These risks are listed in the following table with some suggestions to prevent them.

Table of residual risks

RISK ANALYSIS AND DESCRIPTION	SUGGESTED REMEDY
Noise pollution due to installation in unsuitable environments or where staff work permanently.	Reassess the environment or the place of installation.
Suitable local ventilation that does not cause overheating of the equipment and is sufficient not to create discomfort to people in the room.	Restore suitable ambient conditions and air the room.
External weather conditions, such as water seepage, low temperatures, high humidity, etc.	Maintain ambient conditions suitable for the system.
Overheating of surfaces at temperature (transformers, accumulators, coils, etc.) can cause burns. Also be careful not to block the cooling slits or systems of the equipment.	Use suitable protective equipment or wait for the parts to cool down before switching on the equipment.
Inadequate cleaning: compromises cooling and does not allow the safety labels to be read.	Clean the equipment, labels and work environment adequately.
Accumulation of electrostatic energy can generate hazardous discharges.	Ensure the devices have discharged their energy before working on them.
Inadequate training of staff.	Ask for a supplementary course.
During installation, temporarily mounting the equipment or its components may be risky.	Be careful about and disallow access to the installation area.
Accidental disconnections of the quick-fit connectors with the equipment in operation, or wrong connections, may generate electric arcs	Be careful about and disallow access to the installation area.

General conditions

Some recommendation apply only to large size product or multiple small size product packaging.

Transport and handling

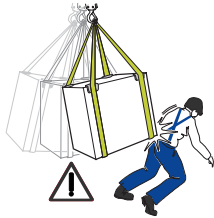

Transport of the equipment, especially by road, must be carried out with means for protecting the components (in particular, the electronic components) from violent shocks, humidity, vibration, etc.

During handling, do not make any sudden or fast movements that can create dangerous swinging.

Lifting



ABB usually stores and protects individual components by suitable means to make their transport and subsequent handling easier, but as a rule, it is necessary to utilize the experience of specialized staff in charge of loading and unloading the components.

The ropes and equipment used for lifting must be suitable for bearing the weight of the equipment.

Do not lift several units or parts of the equipment at the same time, unless otherwise indicated.

Unpacking and checking

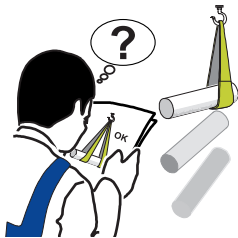



Packaging elements (cardboard, cellophane, staples, adhesive tape, straps, etc.) may cause cuts and/or injuries if not handled with care. They should be removed with the proper equipment.

The components of the packaging must be disposed on in accordance with the regulations in force in the country of installation.

When you open an equipment package, check that the equipment is undamaged and make sure all the components are present. If you find any defects or damage, stop unpacking and consult the carrier, and also promptly inform ABB Service.

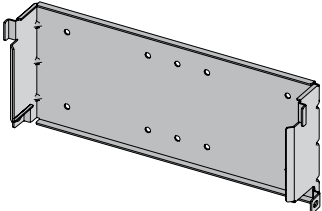
List of components supplied

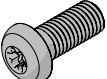
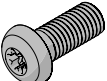
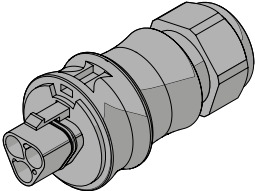
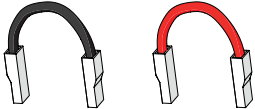
All the components required to correctly install and connect the inverter are supplied together with the inverter.

Available components	Quantity	
	Bracket for wall mounting	1
	M5x10 screw for the external ground connection	1
	M5 contact washer for the external ground connection	2
	(Spare part) T20 screw for front cover	1
	T20 screws for wall bracket locking (to be used when the locking springs are not present, 02 on the bracket)	1
	Watertight connector for AC cable connection	1
	Cable with faston isolated for the configuration of the input channels in parallel	1+1
	Wireless Antenna	1
	Technical documentation	1

Weight of the modules of the equipment

Table: Weights	Weight (Kg/lb)	Lifting points (no.#)
UNO-DM-1.2/2.0/3.0/3.3/4.0/4.6/5.0-TL-PLUS	15 kg / 33 lb	2

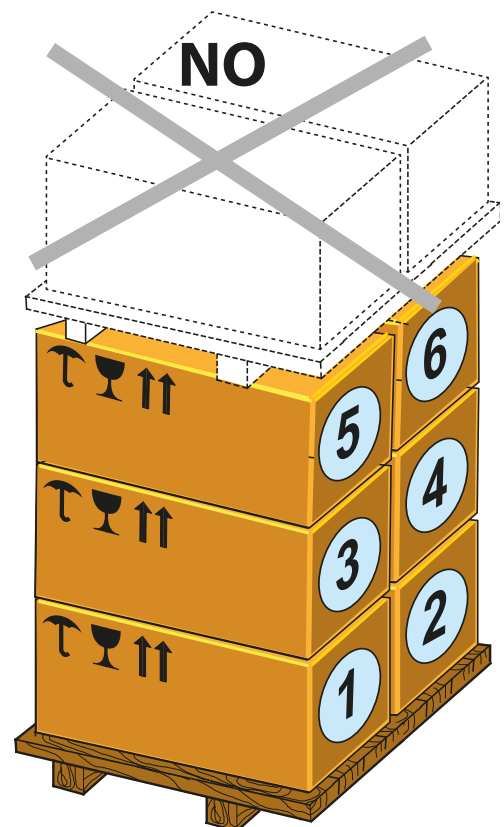
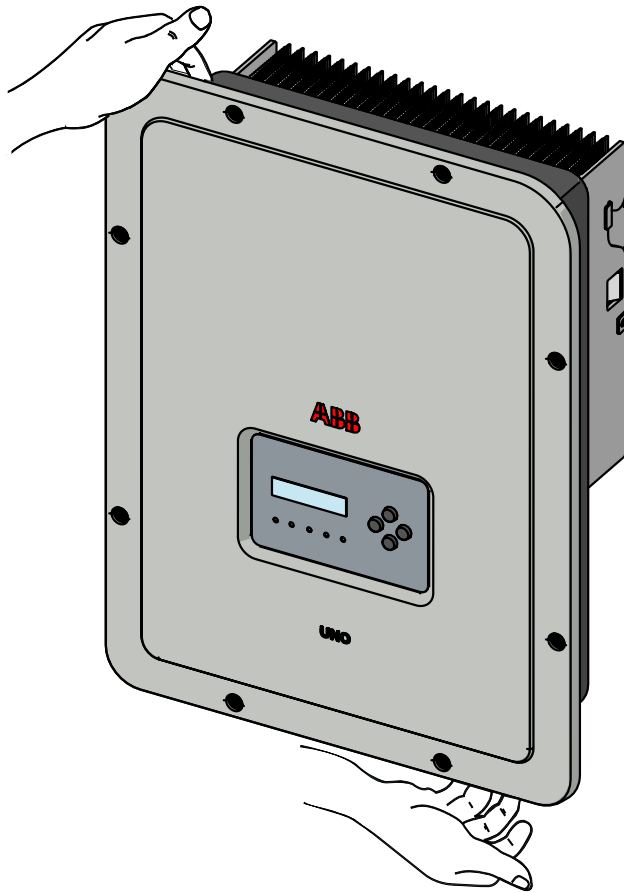

General conditions

The equipment is installed depending on the system and the place where it is installed. Its performance therefore depends on the correctness of the connections.

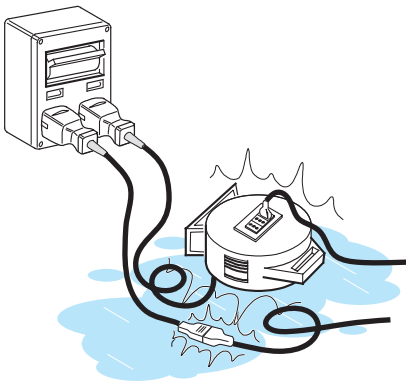

Staff authorised to carry out the installation must be specialised and experienced in this job; they must also have received suitable training on equipment of this type.

The operation must be carried out by qualified personnel and it is advisable to adhere to the indications provided in this manual, the diagrams and the enclosed documentation.



For safety reasons, only a qualified electrician who has received training and/or demonstrated skills and knowledge on the structure and operation of the unit may install the inverter.



The installation must be performed by qualified installers and/or licensed electricians in accordance with the existing regulations in the country of installation.



Connection of the photovoltaic system to an electric installation connected to the distribution grid must be approved by the electricity provider.



The removal of the inverter panels/covers allows access to the area dedicated to service personnel (the operator is not authorized to access this area)



Warning! Electric Shock Hazard! No internal parts of the inverter (included exposed component e.g. Back-up battery, Memory Card, etc...) are to be considered as SELV!



Warning! Electric Shock Hazard! The installation must be carried out with the equipment disconnected from the grid (external power disconnect switch open) and from the photovoltaic generator, with the photovoltaic panels shaded or isolated.



Warning! Electric Shock Hazard! When the photovoltaic panels are exposed to sunlight they provide continuous DC voltage to the inverter.

Environmental checks

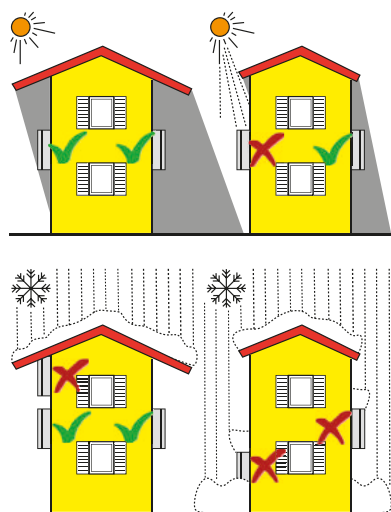

- Consult the technical data to check the required environmental conditions (protection rating, temperature, humidity, altitude, etc.)
- Installation of the unit in a location exposed to direct sunlight must be avoided (otherwise the warranty will be cancelled) as it may cause:
 - power limitation phenomena in the inverter (with a resulting decreased energy production by the system)
 - premature wear of the electrical/electromechanical components
 - premature wear of the mechanical components (gaskets) and of the user interface (display)
- Do not install in small closed rooms where air cannot circulate freely
- Always ensure that the flow of air around the inverter is not blocked so as to prevent overheating.
- Do not install near flammable substances (minimum distance 3 m)
- Do not install near walls made of wood or other flammable substances.
- Do not install in rooms where people live or where the prolonged presence of people or animals is expected, because of the high noise that the inverter produces during operation. The level of the sound emission is heavily influenced by where the inverter is installed (for example: the type of surface around the inverter, the general properties of the room, etc.) and the quality of the electricity supply.
- Avoid electromagnetic interference that can compromise the correct operation of electronic equipment, with the consequent hazards



Final installation of the equipment must not compromise access to any disconnection devices that may be located externally.



Please refer to the warranty terms and conditions to evaluate any possible warranty exclusions due to improper installation.

Installations above 2000 metres



On account of the rarefaction of the air (at high altitudes), particular conditions may occur that should be considered when choosing the place of installation:

- Less efficient cooling and therefore a greater likelihood of the device going into derating because of high internal temperatures.
 - Reduction in the dielectric resistance of the air which, in the presence of high operating voltages (DC input), can create electric arcs (electrical discharges) that may damage the equipment.
- As the altitude increases, the failure rate of some electronic components increases exponentially because of cosmic radiation.



All installations at altitudes of over 2000 metres must be assessed case by case considering the aforesaid criticalities.

Wireless signal environmental checks

The WLAN board of the inverter uses radio waves to transmit and receive data, it is therefore important to assess this factor in order to have optimal installation.

- Walls in reinforced cement and surfaces covered in metal (doors, shutters, etc.) can markedly reduce the reach of the device which even in optimal conditions, should be of approximately 50 metres in free space.
- It is therefore recommended that before installing the inverter, the strength of the wireless signal is checked, using a mobile device (smartphone, tablet or notebook) and connecting to the wireless router from a position which is close to the installation site of the inverter.

Some installation examples are provided below in different conditions and with the maximum recommended distances between the Inverter and the wireless router.

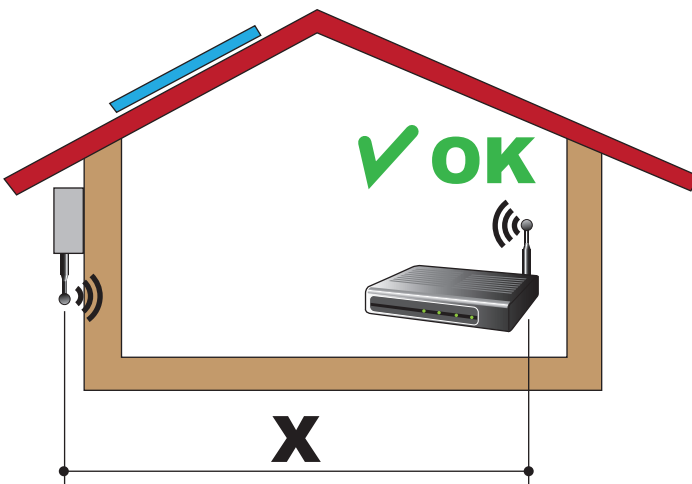

Material of the structure: Wood

Distance X between the Inverter and the wireless Router: less than 10m/33ft

Installation: permitted

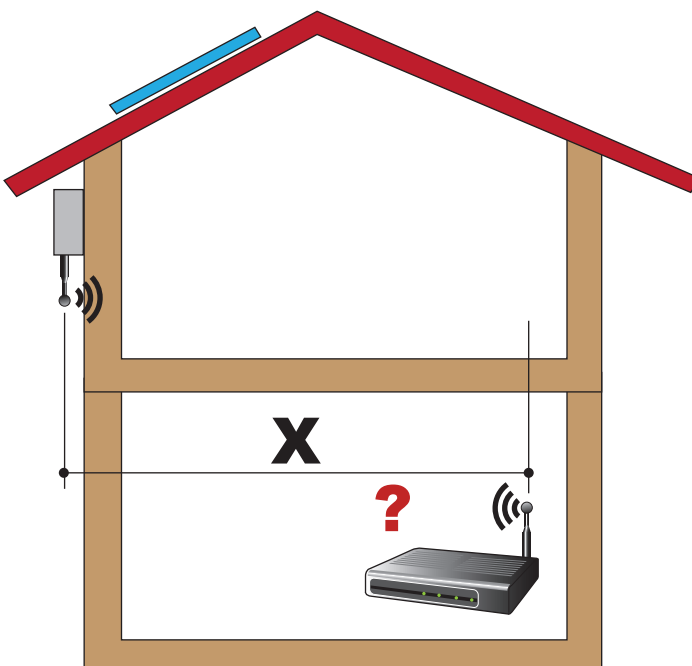

Distance X between the Inverter and the wireless Router: greater than 10m/33ft and/or with obstacles or floors to pass through.

Installation: to be evaluated. Assess the quality of the RF signal and the possibility of extending the signal with a repeater or transferring the Wireless router to the floor above.

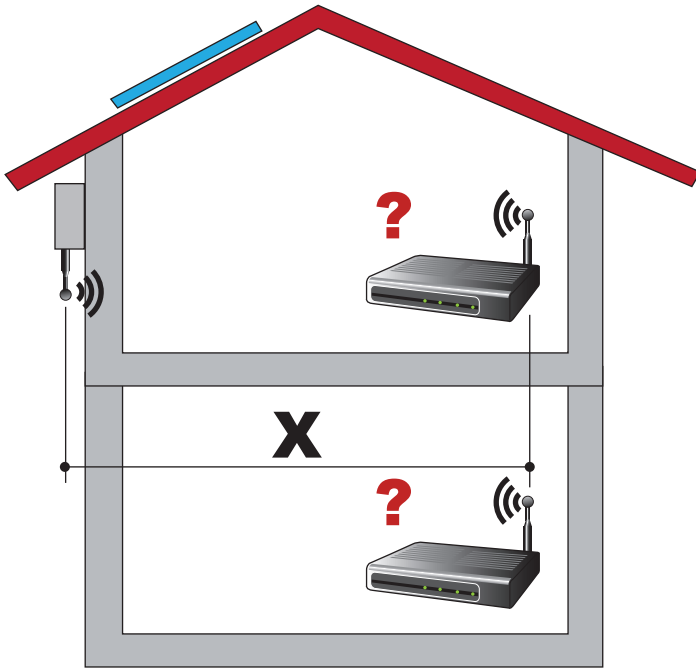

Material of the structure: Concrete

Distance X between the Inverter and the wireless Router: any distance

Installation: to be evaluated. Assess the quality of the RF signal and the possibility of extending the signal with a repeater.

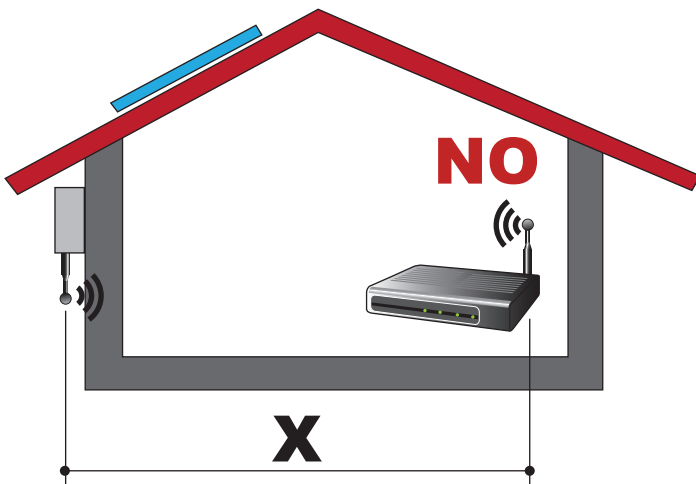

Material of the structure: Metal or reinforced concrete

Distance X between the Inverter and the wireless Router: any distance

Installation: not permitted. Assess the possibility of externally positioning the wireless router antenna (extension) or position the wireless router near a window (in the line of sight of the inverter)



Material of the structure: any material

Distance X between the Inverter and the wireless Router: less than 30m/100ft

Installation: permitted provided that the router is in the line of sight of the inverter (through a window)

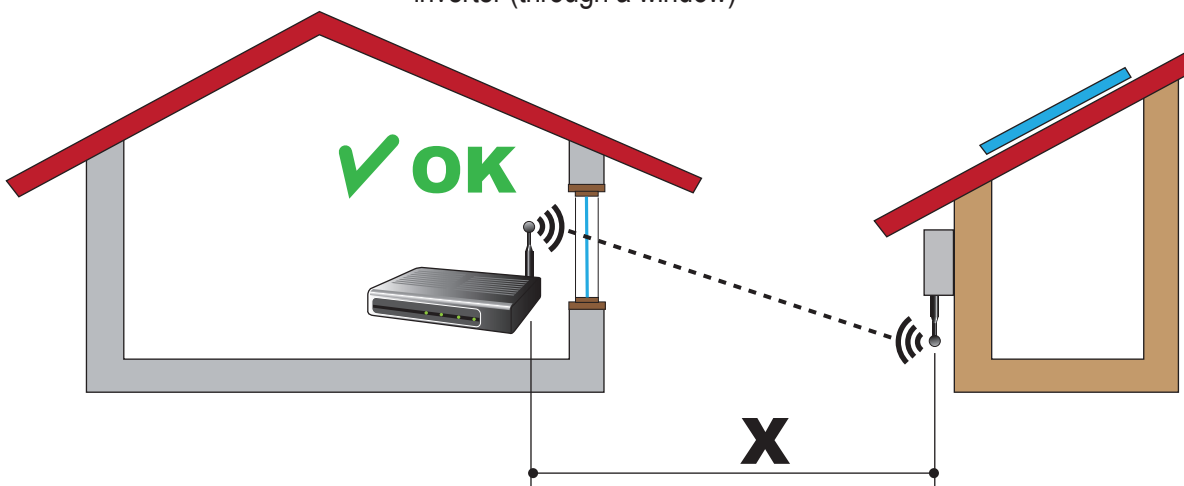

Recommendations for the wireless signal power

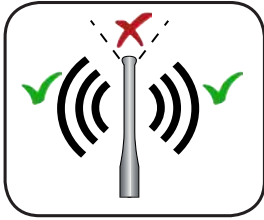

The radio signal level between the inverter and the wireless router can be improved in a number of ways:

1. Change the direction of the antenna.

The antenna has a dead zone at its tip, which should not be positioned facing the wireless router, as shown in the figure.

2. Find a new position for the router considering the different types of materials which the radio signal will have to pass through:

Material	Relative signal reduction
Open field	0% (strength of approximately 50 metres)
Wood / Glass	From 0 to 10%
Stone / Plywood	From 10 to 40%
Reinforced concrete	From 60 to 90%
Metal	Up to 100 %

The quality of the RF signal can be assessed during the installation stage where the signal is displayed in dBm.

3. Install a wireless signal repeater and place it in an area between the inverter and the router, trying to make sure that the most critical obstacles are avoided.

Installation position

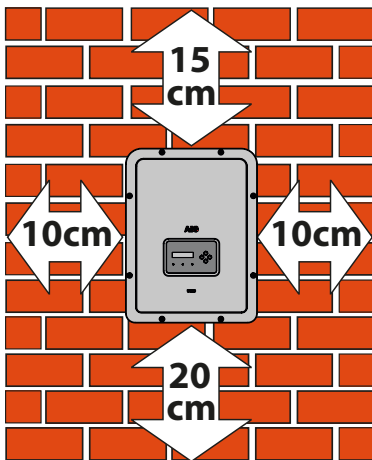
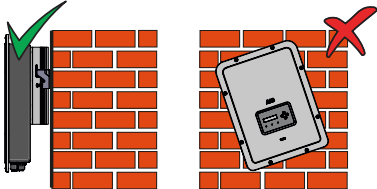
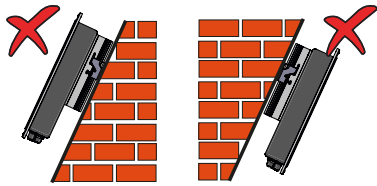

When choosing the place of installation, observe the following conditions:

- Install on a wall or strong structure suitable to bear the weight
- Install in safe, easy to reach locations
- If possible, install at eye-level so that the display and status LEDs can be seen easily
- Install at a height that considers the heaviness of the equipment. Failure to meet this condition could result in problems during servicing, unless suitable means are provided to carry out the operation
- Install vertically with a maximum inclination of 5° (forward or backward). If this condition cannot be met, the inverter could undergo derating due to high temperature because of poor heat dissipation.

- Maintenance on device hardware and software entails removing the front covers. Check that the correct installation safety distances are observed in order to allow routine check and maintenance operations.
- Comply with the minimum distances indicated

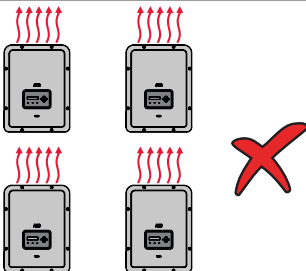
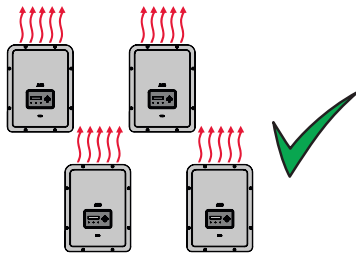
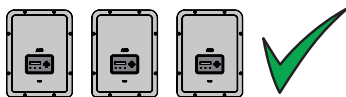

- For a multiple installation, position the inverters side by side.

- If the space available does not allow this arrangement, position the inverters in a staggered arrangement as shown in the figure so that heat dissipation is not affected by other inverters.

Wall mounting



Do not open the inverter in case of rain, snow or high humidity (>95%).
During installation do not place the inverter with the front cover 05 facing the ground.

Install the inverter by following this procedure:

- Place the bracket 01 perfectly level on the wall and use it as a drilling template.
- The selection of the appropriate number and distribution of the anchors is the responsibility of the installer. The choice must be made according to the type of wall, frame or other type of support, and should be sized considering a total load of more than 4 times the weight of the inverter (total 4x15=60 kg total). Depending on the type of anchor chosen, drill the holes required for the fixing of the bracket 01 (Figure A).
- Fix the bracket to the wall or structure.
- Carefully lift the inverter and hook it onto the bracket by inserting the two supports in the slots on the inverter (Figure B).
- Proceed to anchor the inverter to the bracket by installing the two (one each side) locking screws (Figure B1). If on the bracket are present the lateral lock springs, proceed to lock the inverter by pressing the lower part toward the wall or structure until the two springs on the bracket set the inverter in position (Figure B2).

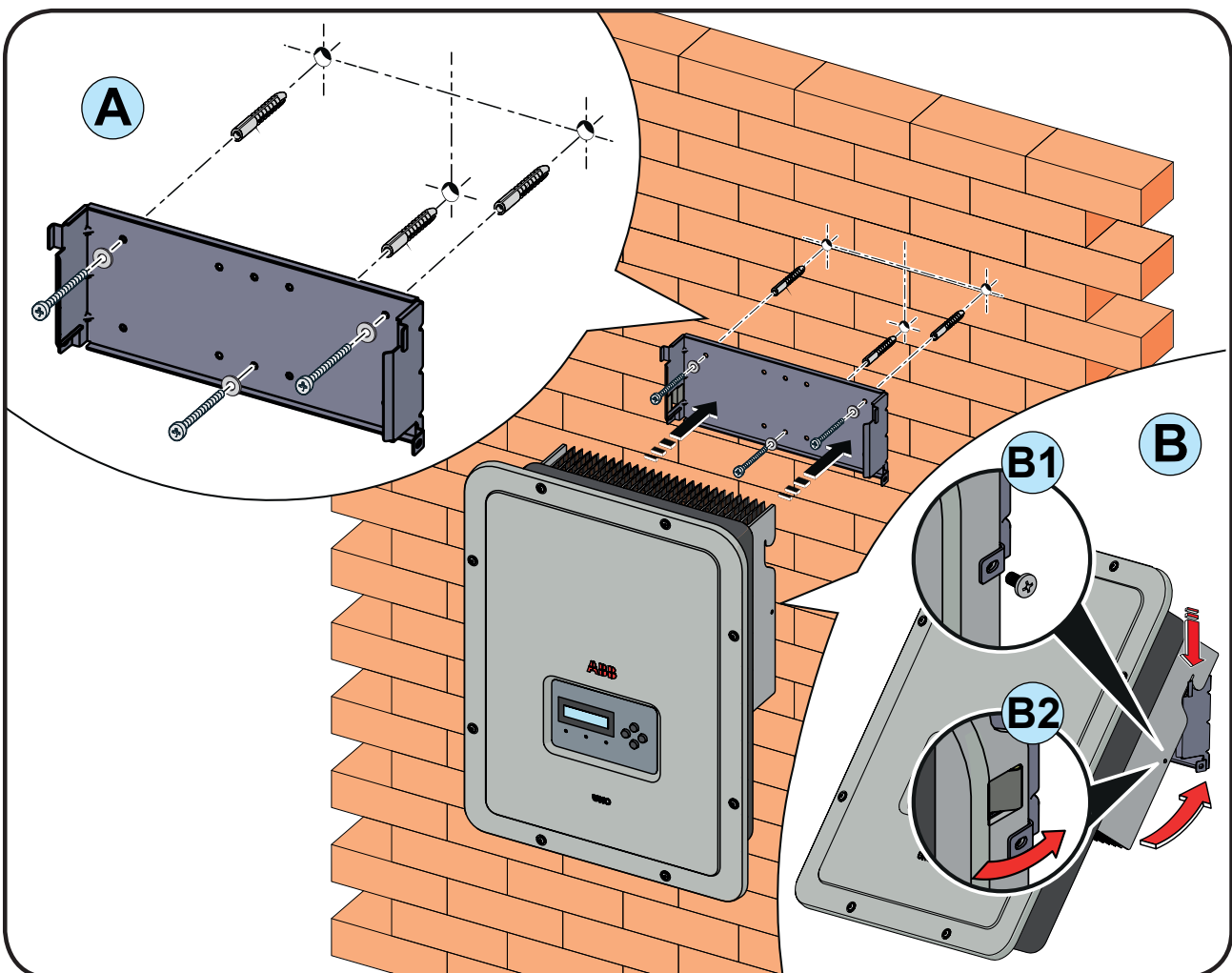

Wireless antenna mounting

Install the wireless antenna (provided in the mounting kit) by following this procedure:

- Remove the external antenna connector protection cap (in red).
- Install wireless antenna by screwing it into the dedicated connector located on the bottom part of the inverter ⑪.

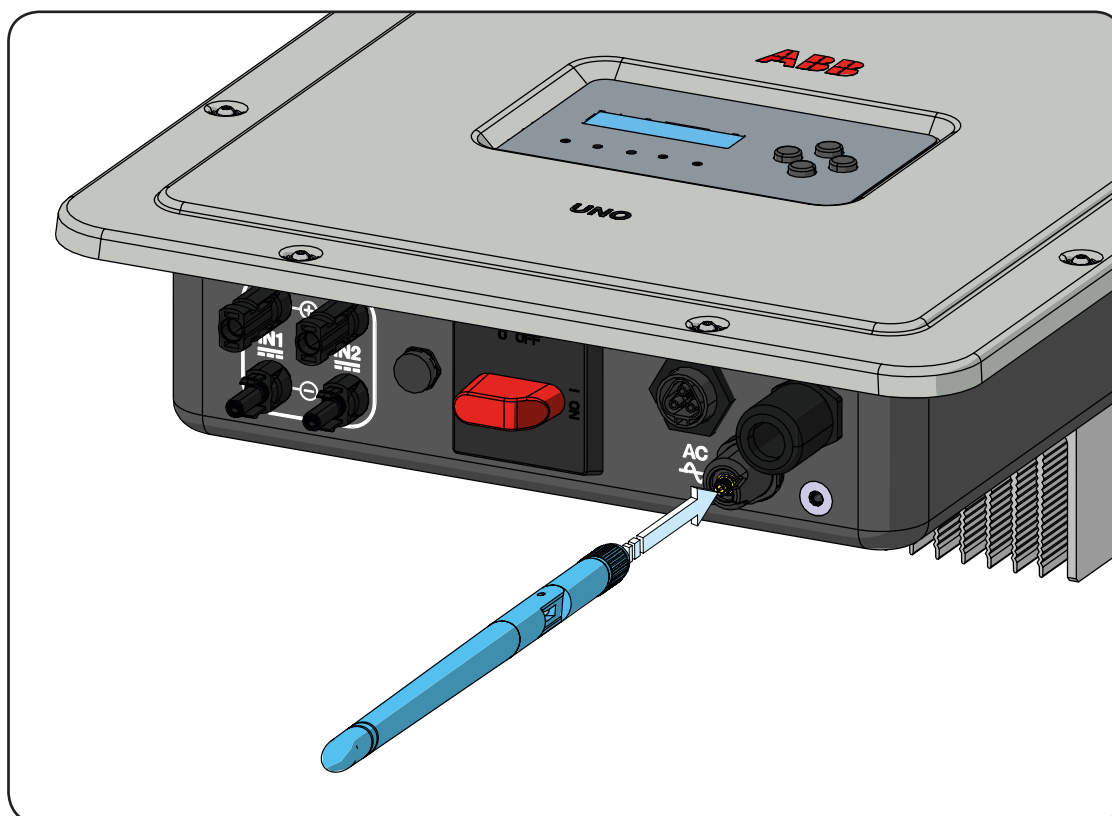

Opening the front cover



WARNING! ELECTRIC SHOCK HAZARD! Hazardous voltages may be present inside the inverter. The access to the internal zones of the inverter must be carried out after a minimum waiting time of 5 minutes since the inverter was disconnected from the grid and from the photovoltaic generator.



The main connections are made on the lower part (outside) of the inverter. If required, install the accessories and make the necessary connections, unscrew the 8 screws using a TORX T20 key and open the front cover (05); while removing the screws, pay special attention since additional screws are not supplied..



Do not open the inverter in the case of rain, snow or a high level of humidity (>95%)



Caution! It's necessary to hold the front cover during the screws removal to avoid his falling (the front cover isn't secured to the inverter's chassis).

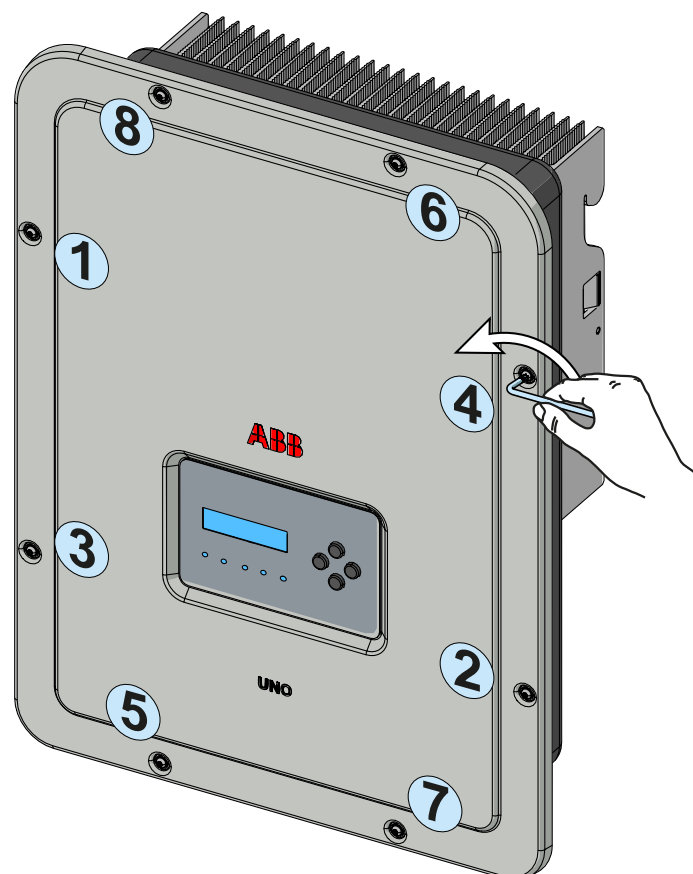

Preliminary operations for connection of the PV generator

Checking the correct polarity of the strings

Using a voltmeter, check that the voltage of each string has the correct polarity and falls within the input voltage limits of the inverter (see technical data).



Polarity inversion can cause serious damage.

If the open circuit voltage of the string is near the maximum value accepted by the inverter, consider that low ambient temperatures cause an increase in the string voltage (different according to the photovoltaic module used). In this case it is necessary to carry out a check of the sizing of the system and/or a check on the connections of the modules of the system (e.g.: number of modules in series higher than the design number).

A configuration program that can help to correctly size the photovoltaic system is available on the ABB website <http://stringsizer.abb.com>.



Checking of leakage to ground of the photovoltaic generator

Measure the voltage present between the positive and negative pole of each string with respect to ground, as described in the section on "Verification of leakage to ground".



Do not connect the strings if a leakage to ground has been detected, as the inverter might not connect to the grid.

Selection of differential protection downstream of the inverter

All ABB string inverters marketed in Europe are equipped with a device for protection against ground faults in accordance with the safety standard IEC 62109-2, sections 4.8.2 and 4.8.3 of the Standard (equivalent to Standard DIN V VDE V 0126-1:2006, section 4.7). In particular, ABB inverters are equipped with a redundancy on the reading of the ground leakage current sensitive to all components of both direct and alternating current. Measurement of the ground leakage current is carried out at the same time and independently by 2 different processors: it is sufficient for one of the two to detect an anomaly to trip the protection, with consequent disconnection from the grid and stopping of the conversion process.

There is an absolute threshold of 300 mA of total leakage current AC+DC with protection tripping time at a max. of 300 msec.

In addition, there are another three tripping levels with thresholds respectively at 30 mA/sec, 60 mA/sec and 150 mA/sec to cover the "rapid" changes in fault current induced by accidental contact with leaking live

parts. The max. tripping times are progressively shortened as the speed of change in the fault current increases and, starting from the 300 msec/ max for the 30 mA/sec change, they are shortened respectively to 150 msec and 40 msec for 60 mA and 150 mA changes.

It should in any case be noted that the integrated device only protects the system against ground faults that occur upstream of the AC terminals of the inverter (namely towards the DC side of the photovoltaic system and consequently towards the photovoltaic modules). The leakage currents that can occur in the AC section between the draw/feed and the inverter are not detected and require an external protection device.

For protection of the AC line, on the basis of the information above with regard to the differential protection integrated in **ABB** inverters, **it is not necessary to install a type B differential switch.**



In accordance with article 712.413.1.1.1.2 of Section 712 of IEC Standard 64-8/7, we hereby declare that, because of their construction, ABB inverters do not inject ground fault direct currents.



The use of an AC type circuit breaker with differential thermal magnetic protection with tripping current of 300 mA is advisable so as to prevent false tripping, due to the normal capacitive leakage current of photovoltaic modules.

In the case of systems which consist of several inverters connected to a single switch with differential protection it is recommended that a device is installed which allows the adjustment of the tripping value and the tripping time.

Independent or parallel input channels configuration

The inverter versions from 3.3kw to 5.0kw are equipped with two input channels (thus benefiting from two trackers for MPPT maximum power point tracking) which work independently of one another, which can be paralleled by leveraging a single MPPT.

Strings of photovoltaic modules having the same type and number of panels in series must be connected to each single channel; they must also have the same installation conditions (in terms of orientation to the SOUTH and inclination from the horizontal plane).

When connecting the two input channels in parallel, you must comply with the above requirements in order to benefit from the ability to leverage the full power of the inverter output on a single channel.

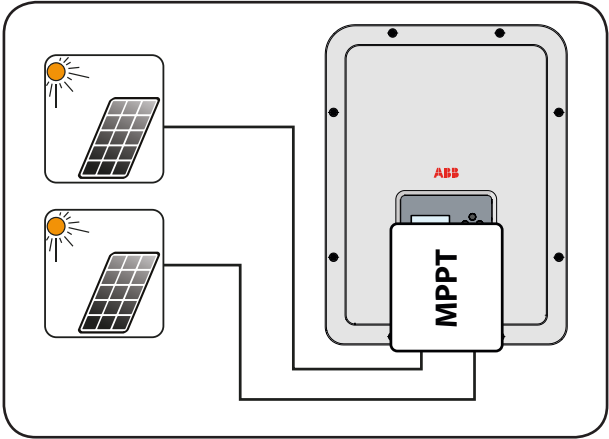

The dual MPPT structure however allows management of two photovoltaic generators which are independent of each other (one for each input channel), and which may differ between themselves with regard to installation conditions, type and number of photovoltaic modules connected in series. A necessary condition for the two MPPT to be used independently is that the photovoltaic generator connected to each of the inputs has a lower power than the power limit of the single input channel and a maximum current lower than the current limit of the single input channel.

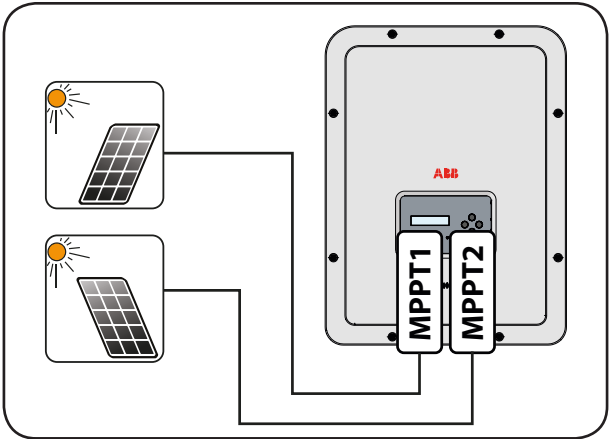

All input parameters that must be met for correct inverter operation are shown in the "technical data" table.

Channel configuration examples

PV generator characteristics	MPPT configuration	Notes
<p>The photovoltaic generator consists of strings having a different number of modules in series from each other.</p> <p>The photovoltaic generator consists of strings that have different installation conditions from each other.</p>	<p>MPPT configuration has to be INDEPENDENT</p>	<p>A NECESSARY condition so that the two MPPTs can be used in independent mode is for the photovoltaic generator connected to each of the inputs to have a power lower than the power limit of the single input channel AND a maximum current lower than the current limit of the single input channel.</p>
<p>The photovoltaic generator consists of strings having the same number of modules in series as each other.</p> <p>The photovoltaic generator consists of strings that have the same installation conditions, that is to say, all the strings have the same inclination from the horizontal and the same orientation to the SOUTH.</p> <p>The photovoltaic generator connected to each of the inputs has a power lower than the power limit of the input channel AND a current lower than the current limit of the input channel.</p>	<p>Possibility of choosing between the configuration with MPPT as INDEPENDENT or PARALLEL</p>	<p>A NECESSARY condition so that the two MPPTs can be used in independent mode is for the photovoltaic generator connected to each of the inputs to have a power lower than the power limit of the input channel AND a maximum current lower than the current limit of the input channel.</p> <p>An ADVISABLE (*) condition so that the two MPPTs can be connected in parallel is for the photovoltaic generator connected to the two inputs to consist of strings made by the same number of modules in series and for all the modules to have the same installation conditions.</p>
<p><i>(*) This condition is advisable from the point of view of the energy production of the system, not from the point of view of inverter operation.</i></p>		
<p>The photovoltaic generator consists of strings having the same number of modules in series as each other.</p> <p>The photovoltaic generator consists of strings that have the same installation conditions, that is to say, all the strings have the same inclination from the horizontal and the same orientation to the SOUTH.</p> <p>The photovoltaic generator connected to each of the inputs has a power higher than the power limit of the input channel OR a current higher than the current limit of the input channel.</p>	<p>MPPT configuration has to be PARALLEL</p>	<p>A SUFFICIENT (*) condition so that the two MPPTs must be used in parallel mode is for the photovoltaic generator connected to each of the inputs to have a power higher than the power limit of the single input channel OR a maximum current higher than the current limit of the single input channel.</p> <p>An ADVISABLE (**) condition so that the two MPPTs can be connected in parallel is for the photovoltaic generator connected to the two inputs to consist of strings made by the same number of modules in series and for all the modules to have the same installation conditions.</p>
<p><i>(*) This condition is sufficient from the point of view of the energy production of the system, not from the point of view of inverter operation.</i></p>		
<p><i>(**) This condition is advisable from the point of view of the energy production of the system, not from the point of view of inverter operation.</i></p>		



Independent channel configuration (default configuration)

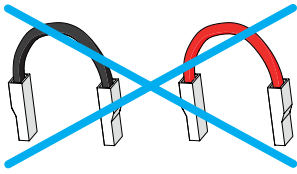

This configuration is set at the factory and involves the use of the two input channels (MPPT) in an independent mode. This means that the jumpers (supplied) between the positive and negative poles of the two DC input channels ⑫ must not be installed, and that the independent channel mode should be set during the commissioning phase, in the dedicated section of the internal webserver “**SETTINGS > SETUP DC SIDE > INPUT MODE**” or through the inverter display menu “**SETTINGS > INPUT MODE**”.

Parallel channel configuration

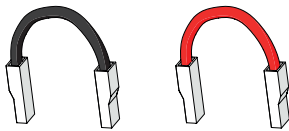

This configuration involves the use of the two input channels (MPPT) connected in parallel. This means that the jumpers (supplied) between the positive and negative poles of the two DC input channels ⑫ must be installed, and that the parallel channel mode should be set during the commissioning phase, in the dedicated section of the internal webserver “**SETTINGS > SETUP DC SIDE > INPUT MODE**” or through the inverter display menu “**SETTINGS > INPUT MODE**”.

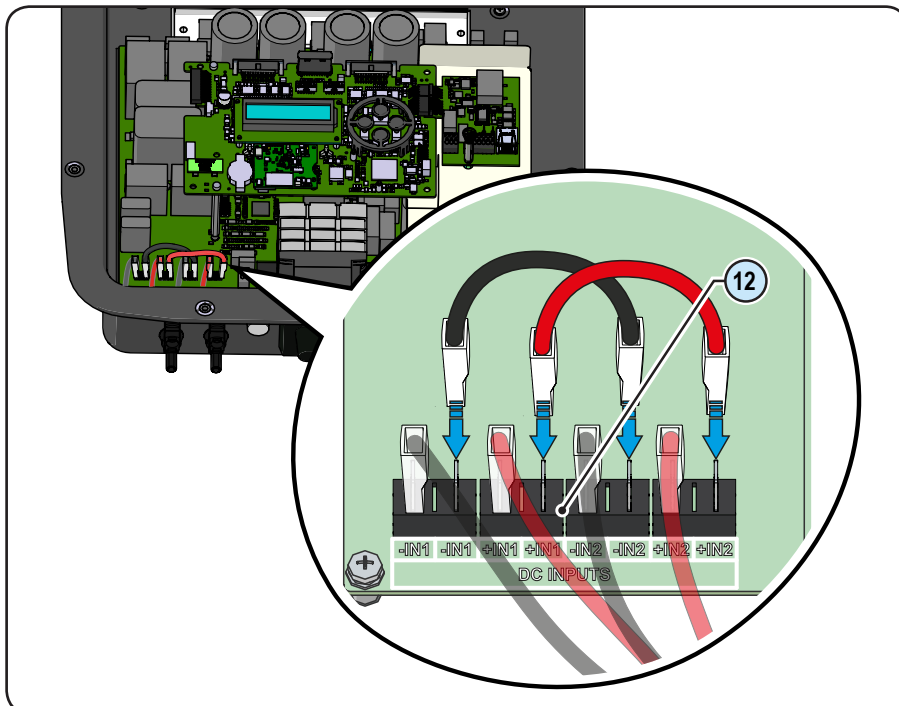

Input connection to PV generator (DC side)

After having carried out preliminary checks and therefore having verified that there are no problems in the photovoltaic system, and the channel configuration has been selected (parallel or independent) you may connect the inputs to the inverter.



According to the system configuration, check the correct setting of the channels to independent or in parallel mode. An incorrect setting of the input channels can lead to loss of energy production.



Comply with the maximum input current relating to the quick-fit connectors as indicated in the technical data.



Polarity inversion can cause serious damage. Check polarity before connecting each string!



When the photovoltaic panels are exposed to sunlight they provide continuous DC voltage to the inverter. To avoid risks of electrical shock, **all wiring operations must be carried out with the DC disconnect switch (internal or external to the inverter) OFF.**



Caution! The inverters referred to in this document are TRANSFORMERLESS. This type requires the use of insulated photovoltaic panels (IEC61730 Class A Rating) and the need to keep the photovoltaic generator floating with respect to ground: no terminal of the generator must be connected to ground.

For the string connections it is necessary to use the quick fit connectors (usually Weidmüller PV-Stick or WM4, MultiContact MC4 and Amphenol H4) located on the bottom of the mechanic 09.

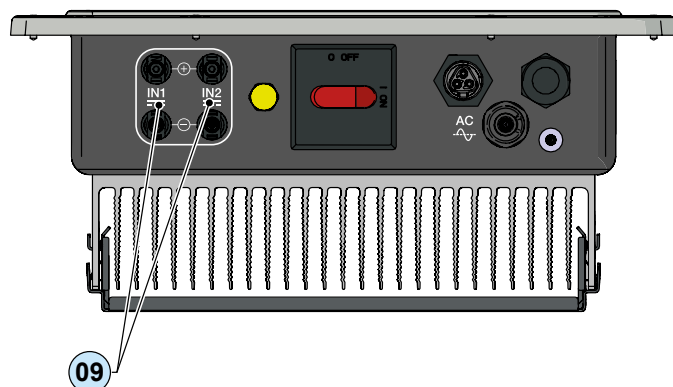

Refer to the document “String inverter – Product Manual appendix” available at www.abb.com/solarinverters to know the brand and the model of the quick fit connector. Depending on the model of the connector of the own inverter, it is necessary to use the same model and the respective counterpart (check the compliant counterpart on the website of the manufacturer or in ABB)



Using corresponding parts that are not compliant with the quick fit connector models on the inverter could cause serious damage to the unit and lead to invalidation of the warranty.

Connect all the strings required by the system, always checking the seal of the connectors.

The figure below shows a connection example of the string inputs on a UNO-DM-3.3-TL-PLUS-SB inverter.

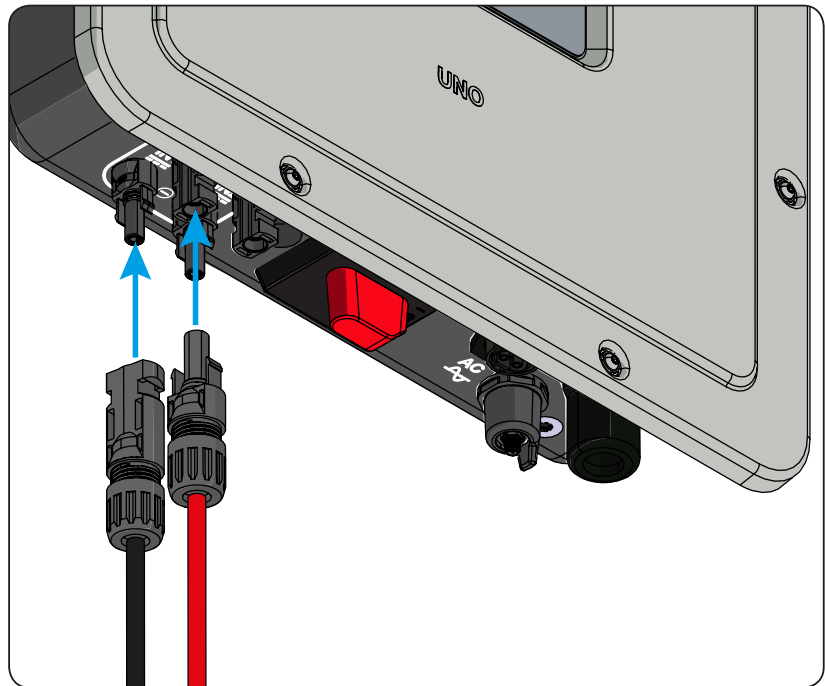

If any string inputs are not required, you must ensure that covers are installed to the connectors, and install any which are missing.

This is necessary both for the inverter seal, and to avoid damage to the free connector which may be used at a later time.

Installation procedure for quick-fit connectors

In the inverter models, where the quick-fit connectors are used, is possible to find one of the following four types:

- Weidmüller PV-Stick
- Weidmüller WM4
- MultiContact MC4
- Amphenol H4.

Please refer to the document “String inverters – Product manual appendix” available at www.abb.com/solarinverters for information on the quick-fit connector brand and model used in the inverter.

The model of connectors installed on your inverter must be matched by the same model of the respective corresponding parts to be used (checking the conforming corresponding part on the manufacturer's website or with ABB).



Using corresponding parts that are not compliant with the quick-fit connector models on the inverter could cause serious damage to the unit and lead to invalidation of the warranty.



CAUTION: To avoid damage to the equipment, when attaching cables, pay particular attention to polarity.

1. WEIDMÜLLER PV-Stick quick-fit connectors

Installation of Weidmüller PV-Stick connectors does not require any special tooling.

- Strip the cable to which you want to apply the connector (after verifying that it complies with the connector limits).

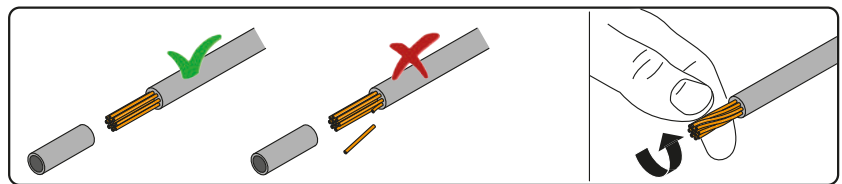
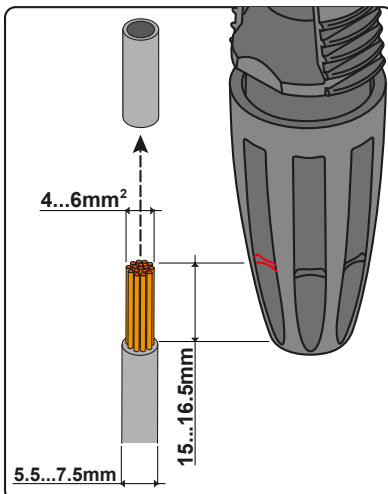

- Insert the wire into the connector until you hear a locking "click".

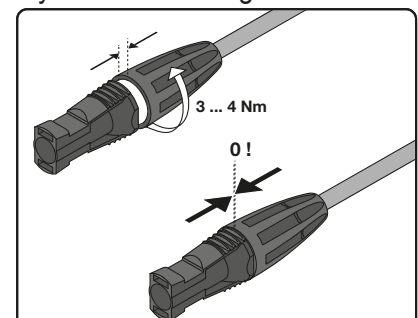
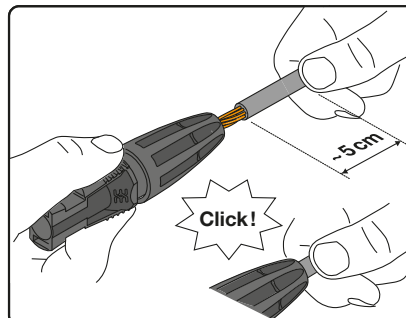

- Tighten the knurled ring nut for optimal clamping.

2. WEIDMÜLLER WM4 quick-fit connectors

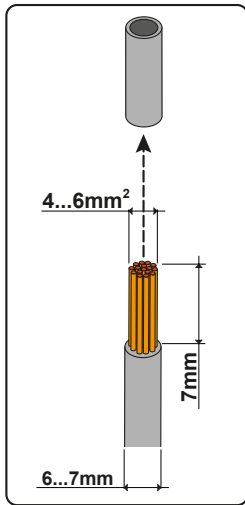

Installation of Weidmüller WM4 connectors requires crimping to be carried out with suitable equipment.

- Strip the cable to which you want to apply the connector (after verifying that it complies with the connector limits).

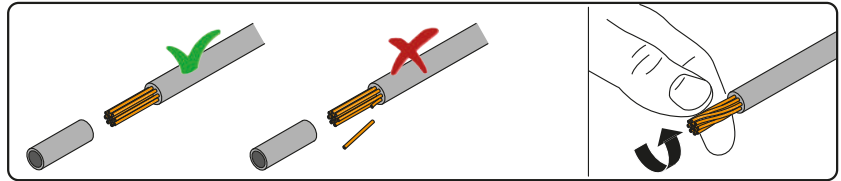

- Apply the terminal to the conductor using the designated pliers.

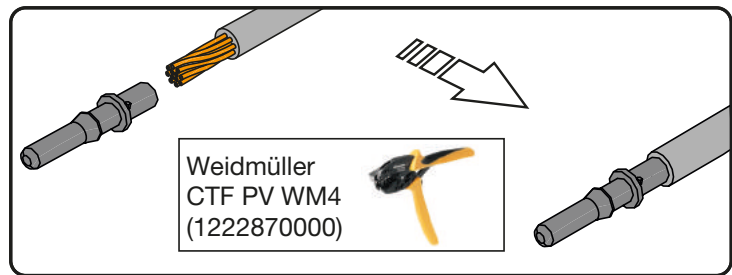

- Insert the cable with the terminal into the interior of the connector, until you hear the click indicating that the terminal is locked inside the connector.

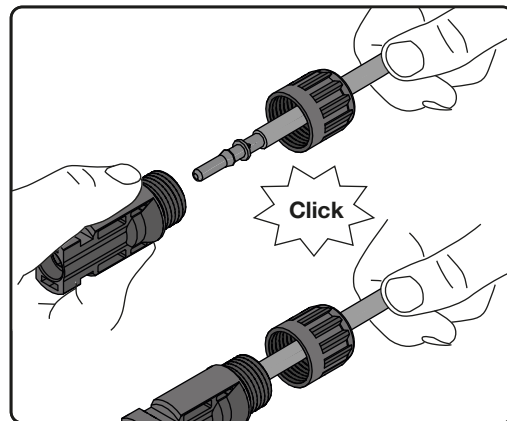

- Firmly tighten the cable gland using the relevant tool to finish the operation.

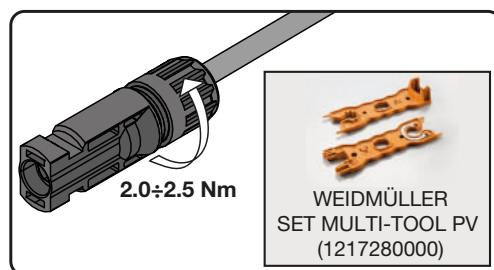

3. MULTICONTACT MC4 quick-fit connectors

Installation of Multicontact MC4 connectors requires crimping to be carried out with suitable equipment.

- Strip the cable to which you want to apply the connector (after verifying that it complies with the connector limits).

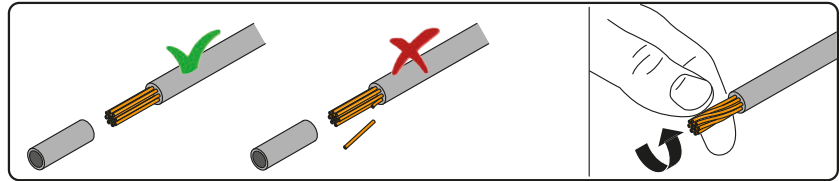
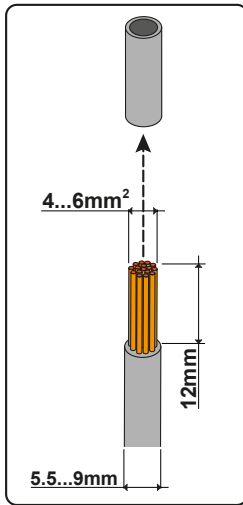

- Apply the terminal to the conductor using the designated pliers.

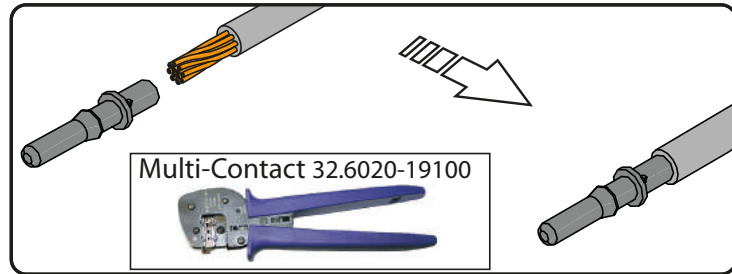

- Insert the cable with the terminal into the interior of the connector, until you hear the click indicating that the terminal is locked inside the connector.

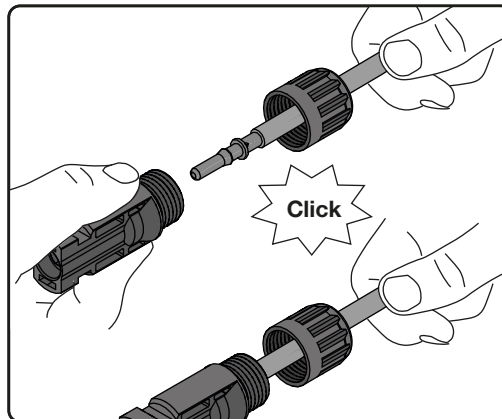

- Firmly tighten the cable gland using the relevant tool to finish the operation.

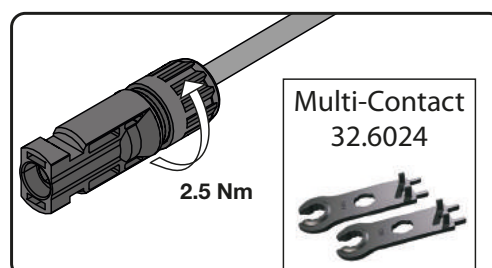

4. AMPHENOL H4 quick-fit connectors

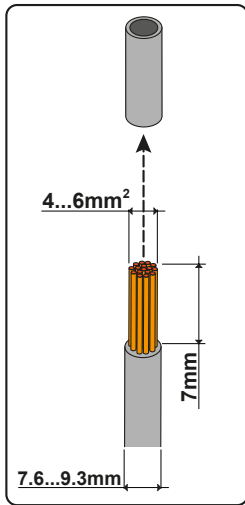

Installation of Amphenol H4 connectors requires crimping to be carried out with suitable equipment.

- Strip the cable to which you want to apply the connector (after verifying that it complies with the connector limits).

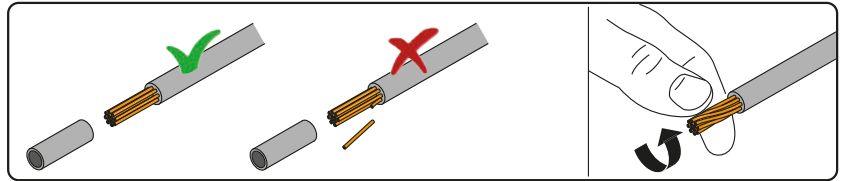

- Apply the terminal to the conductor using the designated pliers.

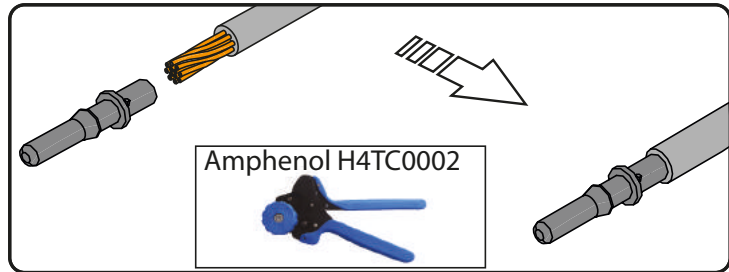

- Insert the cable with the terminal into the interior of the connector, until you hear the click indicating that the terminal is locked inside the connector.

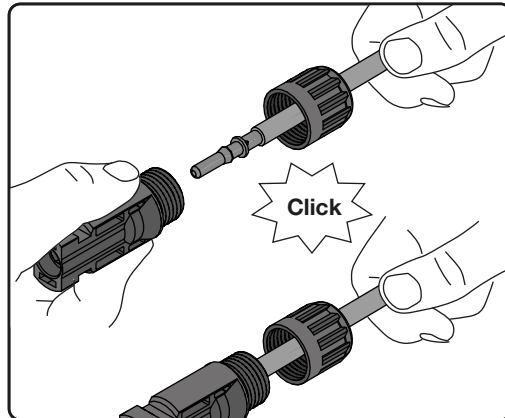

- Firmly tighten the cable gland using the relevant tool to finish the operation.

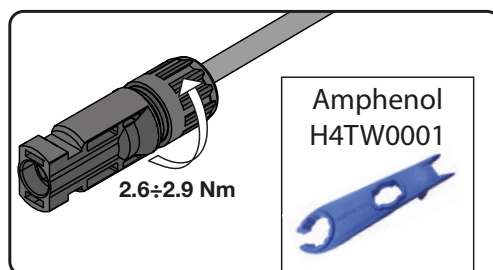

Distribution grid output connection (AC side)

To connect the inverter to the grid you need 4 connections: ground, neutral, phase and external grounding protection **In any case, connection of the inverter to ground is mandatory.**



Any failure of the inverter when it is not connected to ground through the appropriate terminal (AC connector) and to the metal frame (external grounding protection) is not covered by the warranty.

The connection of the grid cable to the inverter is realised through the dedicated AC output connector ⑩ by carrying out the following operations:

- Characteristics and sizing of the line cable
- Installation of the cable on the AC output connector ⑩
- Connection of the AC output connector to the inverter

Characteristics and sizing of the line cable

The cross-section of the AC line conductor must be sized in order to prevent unwanted disconnections of the inverter from the grid due to high impedance of the line that connects the inverter to the power supply; If the impedance is too high it causes an increase in the AC voltage which, on reaching the limit set by the standards in the country of installation, causes the inverter to switch off.

In order to allow installation of the grid cable inside the AC output connector ⑩, the sizings indicated in the figure must be observed

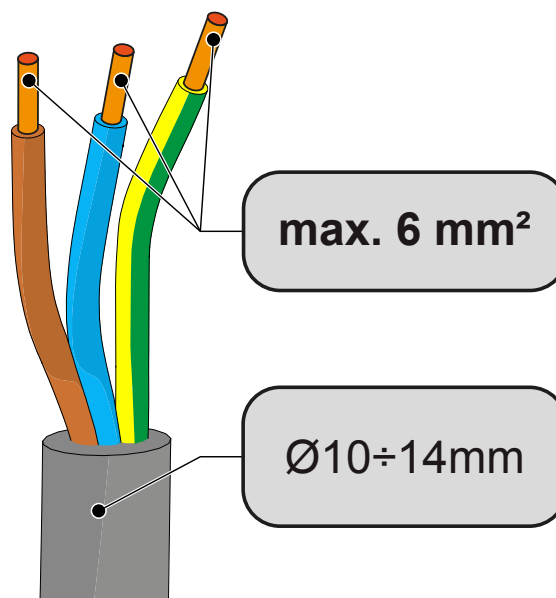

The table shows the maximum line conductor length in relation to the section of the conductor itself:

Line conductor cross section (mm ²)	Line conductor maximum length (m)					
	UNO-DM-1.2	UNO-DM-2.0	UNO-DM-3.3	UNO-DM-4.0	UNO-DM-4.6	UNO-DM-5.0
1.5	18 m	10 m	6 m	5 m	4 m	/
2.5	22 m	15 m	11 m	10 m	8 m	6 m
4	40 m	25 m	19 m	16 m	13 m	10 m
6	56 m	38 m	29 m	24 m	20 m	16 m



The values are calculated in nominal power conditions, considering:

- loss of power along the line no greater than 1%
- use of copper cable, with HEPR rubber insulation and positioned in open air

Load protection switch (AC disconnect switch)

To protect the inverter and the AC connection line, a device must be installed to protect against maximum current and leakage to ground, with the following characteristics:



	UNO-DM-1.2	UNO-DM-2.0	UNO-DM-3.3	UNO-DM-4.0	UNO-DM-4.6	UNO-DM-5.0
Type	Automatic circuit breaker with differential thermal-magnetic protection					
Voltage rating	230 Vac					
Current rating	10 A	16 A	20 A	25 A	25 A	32 A
Magnetic protection characteristic	B/C					
Differential protection type	A/AC					
Differential sensitivity	300 mA					
Number of poles	2					

Installation of the cable on the AC output connector

- Remove the head of the connector by pressing on the two holding clips and subsequently loosen the cable gland.

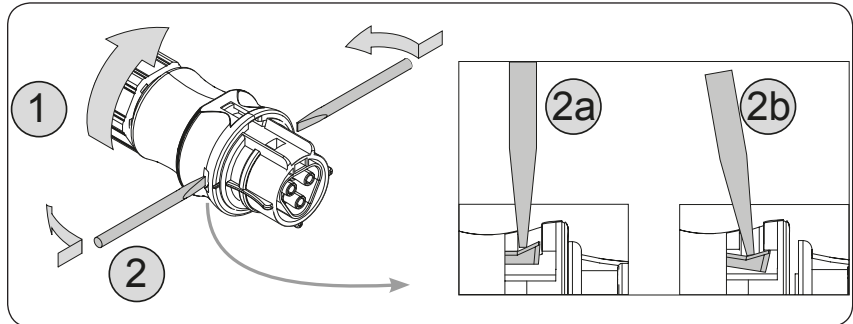

- Feed the cable through the connector and cut the cable to size

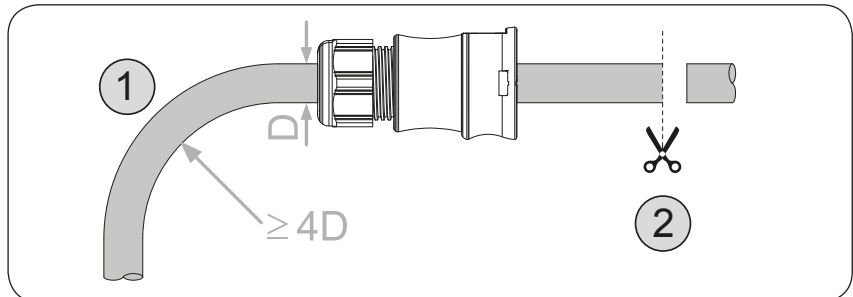

Ensure that the cable's radius of curvature is more than 4 times the diameter of the cable

- Prepare the cable respecting the following measurements. It's possible to use both stranded or solid wire but the requirements are different.

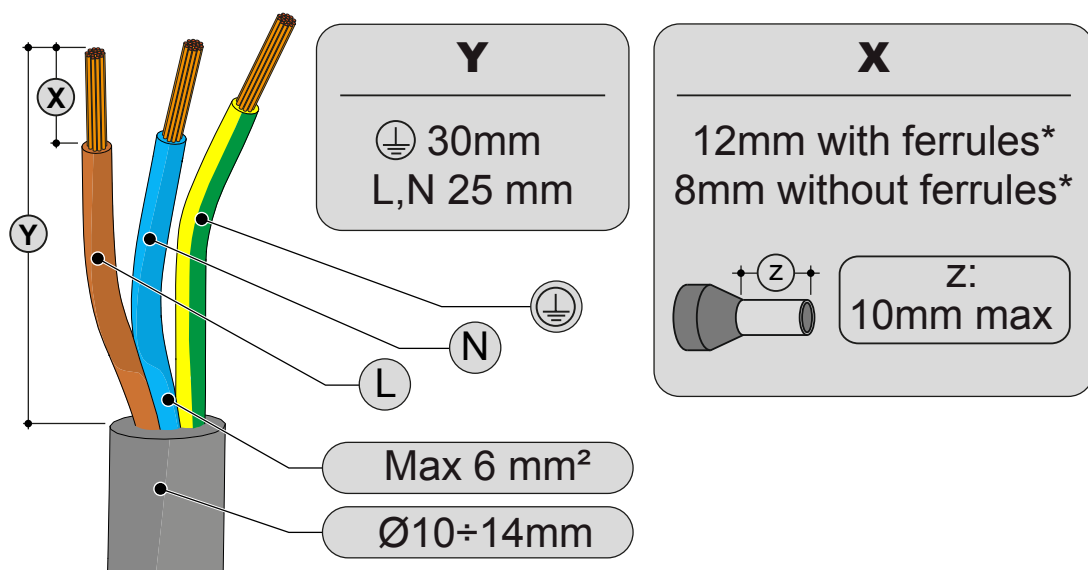

(*): The use of stranded wire with a conductor section values between 1.5 - 4 mm² are only allowed with the mandatory use of properly crimped ferrules.

- Install the single wires (phase, neutral and ground) on the head of the connector respecting the indications printed on each of the three connection terminals (tightening torque 0.8...1Nm)

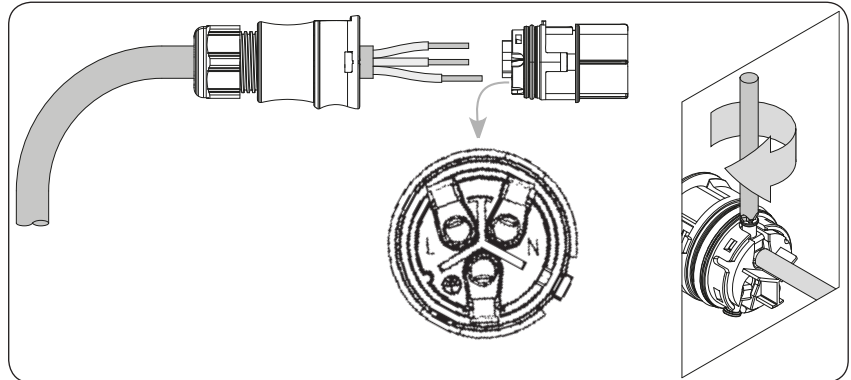

- Close the connector and tighten the cable gland respecting the tightening torque (4+1Nm) in order to guarantee the IP65 protection level

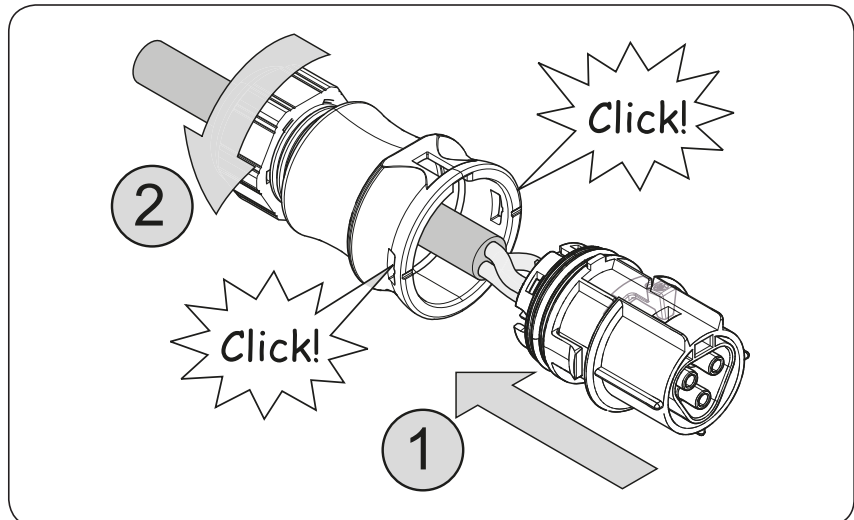

Connection for the AC output connector to the inverter



To avoid risks of electrical shock, all wiring operations must be carried out with the disconnect switch downstream of the inverter (grid side) off.

For all inverter models, connection to the electrical grid is carried out using the AC output connector ⑩.

- Remove the pre-installed protective cover on the inverter.
- Insert the corresponding part in the AC output connector ⑩ being careful to align the reference points (present on both connectors) which prevent connection errors.

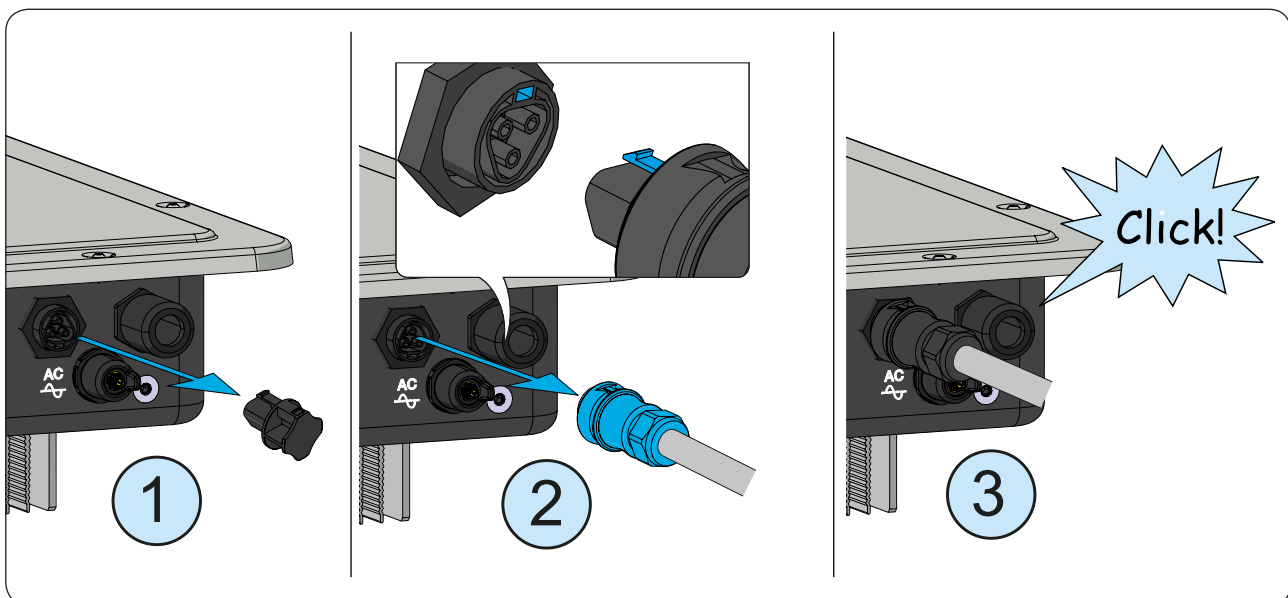

IP65

In order to maintain the inverter's level of IP protection, the corresponding part must be installed with the AC cable connected or the protective cover, on the AC output connector. In addition, the connector must not be subject to tensile forces (examples: do not connect weights to the AC cable, do not leave excess cable windings hanging, etc).

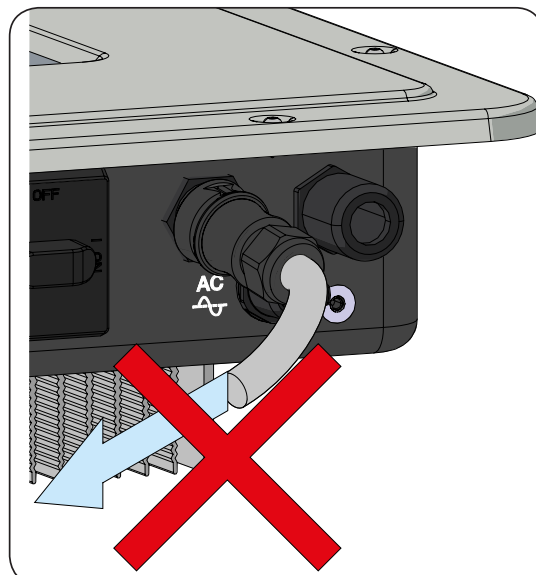

Installation of the external protective grounding cable

In addition to the grounding protection previously connected to the AC output connector, a second protective grounding cable has to be installed to be connected to the metal frame of the inverter.

The cable to be used must be copper and have a minimum cross-section not less than the phase cable and in any case not less than 4mm².

To install a second protective grounding cable, follow the procedure described below:

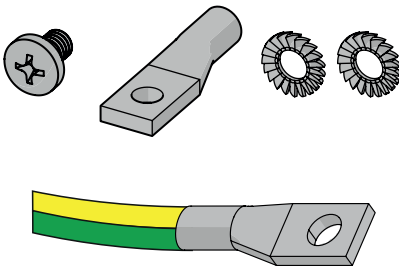

- From among the components supplied, find the M5x10 screw and the two M5 knurled washers.

- Fit a proper cable lug on the protective grounding cable.

- Fasten the cable lug using the screw and the two washers, following the sequence illustrated below and tightening to a torque of 4.1 Nm. The connection point ⑲ is located on the underside of the inverter.

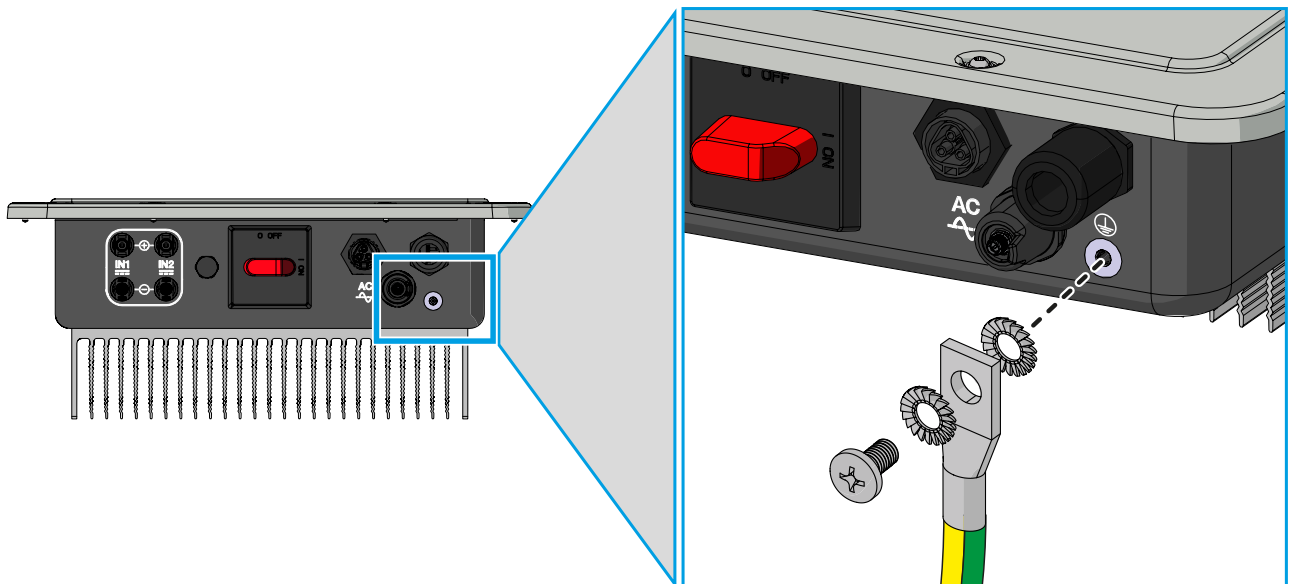

Communication and control signal connections to the UNO-DM-COM KIT board (only for -X / -E version)

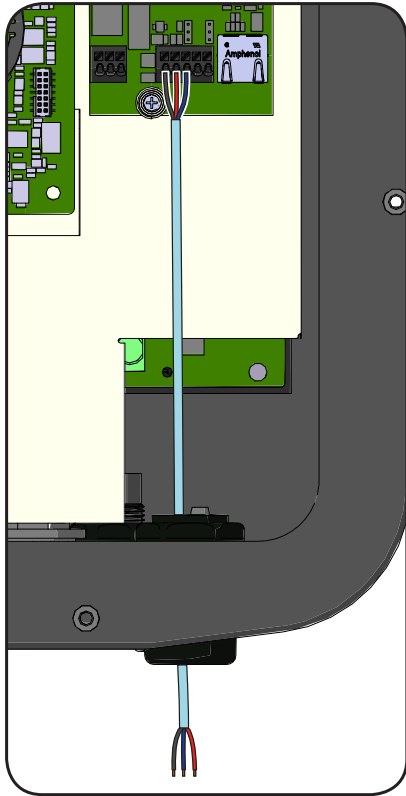

Each cable which must be connected to the UNO-DM-COM KIT or UNO-DM-PLUS-COM Ethernet KIT board connectors must be passed through the specific cable conduit present on the plastic shield of the mainboard, then it must be passed through the service cable glands (20) present on the lower side of the inverter. An M25 cable gland (that takes cables from 10 mm to 17 mm in diameter) and a gasket with two holes to insert into the cable gland which enables two separate cables of a maximum diameter of 6 mm to be accommodated, are available.

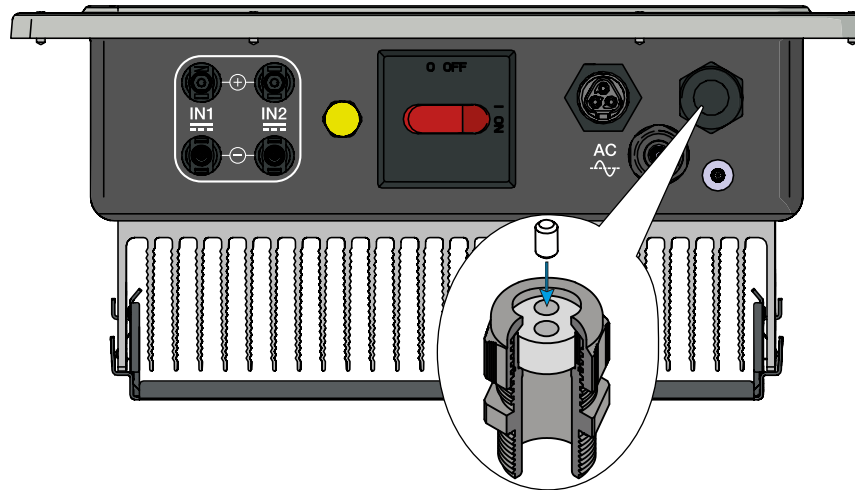

IP65

Warning! To ensure environmental protection IP65 it is necessary to fix the cable glands to the inverter chassis with a minimum tightening torque of 7.5 Nm

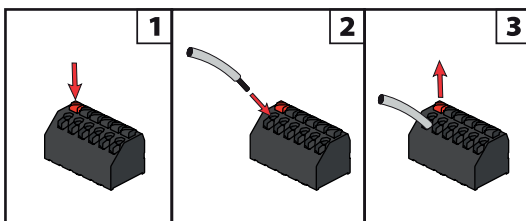

The connection of the wires to the terminals is performed as follows:

1. Press and hold the button corresponding to the terminal where the wire is to be connected
2. Insert the cable
3. Release the button
4. Pull the wire to check the tightness.

Description of terminal blocks on the UNO-DM-COM KIT board (only for -X version)

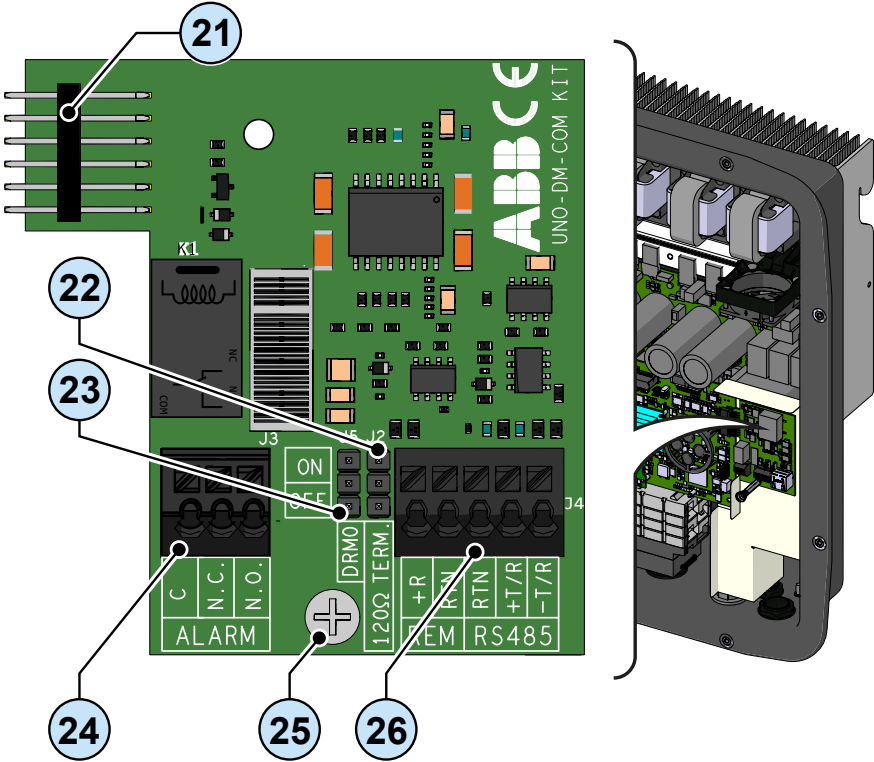

Description of multifunctional relay terminal block 24:

Terminal name	Terminal number	Description
ALARM	N.C.	"Normally closed" terminal of multifunctional relay
	C	"Common" terminal of multifunctional relay
	N.O.	"Normally open" terminal of multifunctional relay

Description of communication and control signal terminal block 26:

Terminal name	Terminal number	Description
REM	+R	Remote external ON/OFF command
	RTN	Reference (RTN) of the Remote external ON/OFF command
RS485	RTN	Reference (RTN) of the RS485 communication line
	+T/R	+T/R of the RS485 communication line
	-T/R	-T/R of the RS485 communication line

Description of terminal blocks on the UNO-DM-PLUS-COM Ethernet KIT board (only for -E version)

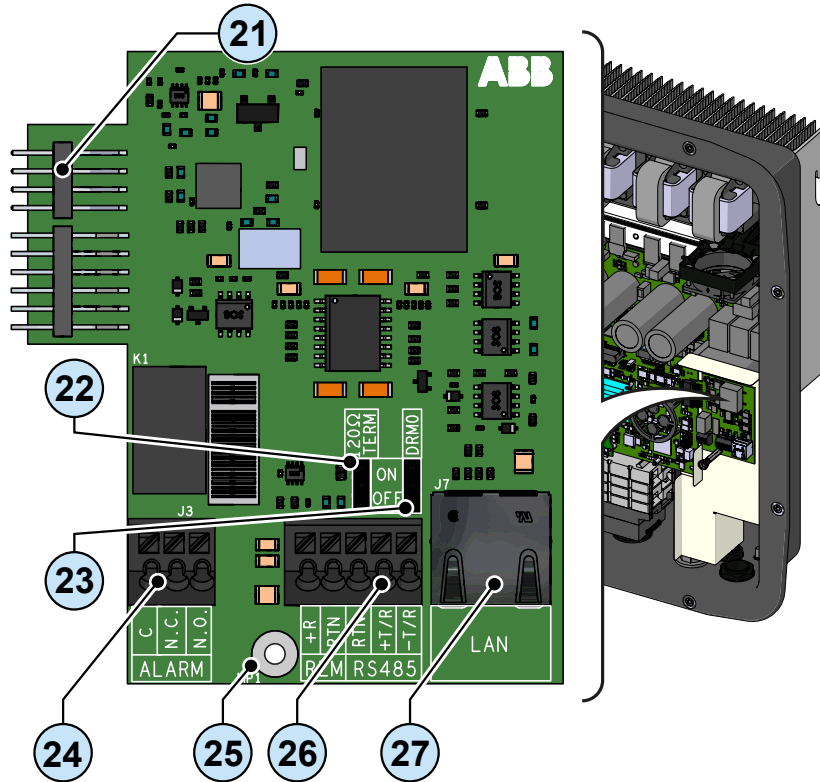

Description of multifunctional relay terminal block ②④:

Terminal name	Terminal number	Description
ALARM	N.C.	"Normally closed" terminal of multifunctional relay
	C	"Common" terminal of multifunctional relay
	N.O.	"Normally open" terminal of multifunctional relay

Description of communication and control signal terminal block ②⑥:

Terminal name	Terminal number	Description
REM	+R	Remote external ON/OFF command
	RTN	Reference (RTN) of the Remote external ON/OFF command
RS485	RTN	Reference (RTN) of the RS485 communication line
	+T/R	+T/R of the RS485 communication line
	-T/R	-T/R of the RS485 communication line

Connection of the RS485 line

On the inverter models which equip the UNO-DM-COM KIT board (-X or -E version only) it is possible to use the RS485 communication port for: Connecting the inverter to an external supported energy meter (to manage the energy produced by the PV plant with the Dynamic Feed-in control functionality); Integrating the inverter with a third party monitoring and control systems; Carrying out “daisy-chain” (“in-out”) connections of multiple inverters installation; Setting internal inverter parameters with the dedicated advanced configuration software “Aurora Manager Lite”.



The inverter RS485 communication protocol must be properly configured depending on the device to which it communicates. The RS485 protocol can be changed through the relevant section of internal webserver (see the specific chapter) or through the display and the keyboard (see the specific chapter).

The connection of the serial communication cable must be made to the specific RS485 connector ②⑥ present on the UNO-DM-COM KIT board.

For connection of the RS485 communication line is necessary a three-wire shielded cable. The cable specifications are described in the following table:



Cable type	AWG	Characteristic impedance	Operating voltage	Operating temperature
Shielded	22 - 24	120 Ohm	≥300 V	-20...+60 °C

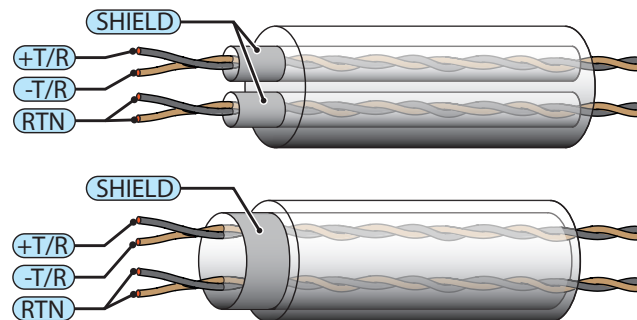

Shield continuity must be provided along the communication line and must be grounded at a single point. It is recommended not to exceed a length of 1000m for the communication line.

The cabling of the RS485 line must be wound up to the toroidal provided in the package (1 winding); this toroidal shall be conveniently placed near the cable gland which is in the bottom part of the inverter.

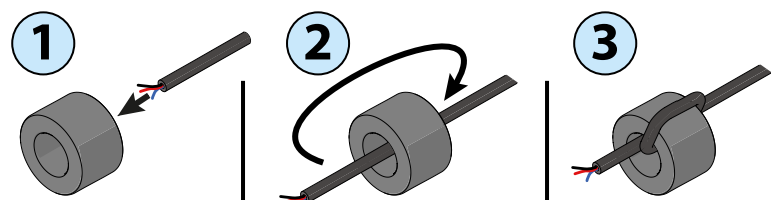

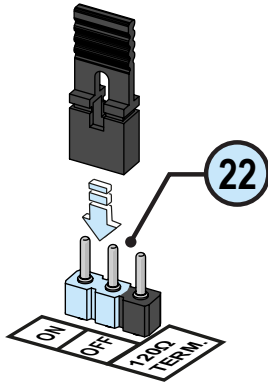

The RS485 HALF-DUPLEX communication line is made up of two transmission and reception cables (+T/R and -T/R) and a communication reference cable (RTN): all three cables must be connected in daisy-chain configuration (it's recommended to make connection external to the inverter).

The RS485 connection can be made by using the terminal block (26).

The last inverter of a daisy chain shall be terminated: within the last inverter itself the provided jumper at the pins marked "120Ohm TERM." shall be placed in ON position in order to enable the termination the RS485 communication line (22) with a resistance present onboard.

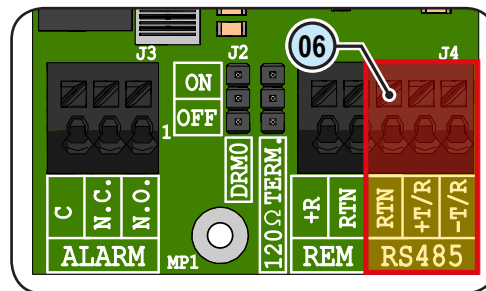

If the RS485 communication line is used to connect an energy meter it will not be possible to connect other unit with daisy-chain.

After the connection is completed RS485 inverter address have to be chosen between 1 and 63.

The setting of the address on the inverter is done through the relevant section of internal webserver (see the specific chapter) or through the display and the keyboard (see the specific chapter).

Each inverter is supplied with the preset RS485 address "2" and with the jumper termination resistance (22) in the OFF position.

Remote control connection

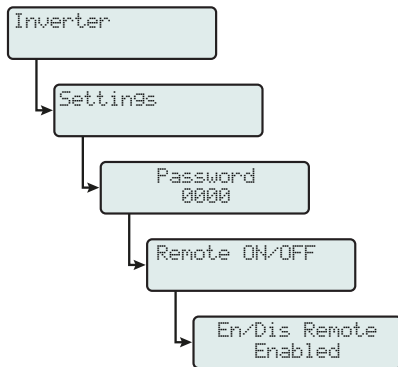

The connection and disconnection of the inverter to and from the grid can be controlled through an external control.

The function must be enabled in the specific section of internal webserver (see the specific chapter) or through the display and the keyboard in the specific menu (see the side picture). If the remote control function is disabled, the switching on of the inverter is dictated by the presence of the normal parameters that allow the inverter to connect to the grid. If the remote control function is operating, besides being dictated by the presence of the normal parameters that allow the inverter to connect to the grid, start-up of the inverter also depends on the state of the terminal **R+** compared to the terminal **RTN** present on the connector ②⑥.

When the **R+** signal is brought to the same potential as the **RTN** signal (that is to say when a short-circuit is created between the two connector terminals), the inverter is disconnected from the grid.

The remote control OFF condition is shown on the display.

Connections for this command are made between input “**R+**” and “**RTN**”.

Since this is a digital input, there are no requirements to be observed as regards cable cross-section (it only needs to comply with the sizing requirement for passing cables through the cable glands ②⑩ and the terminal connector ②⑥). The cable specifications are described in the following table:

AWG	Operating voltage	Operating temperature
22 - 24	≥300 V	-20...+60 °C

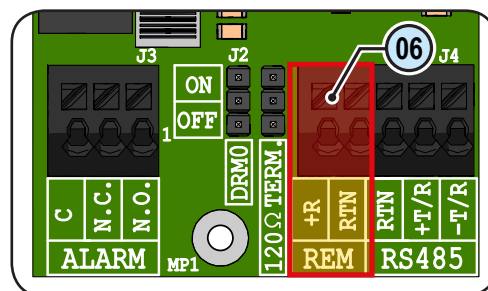

Demand Responce Mode 0 (Request by AS/NZS 4777)

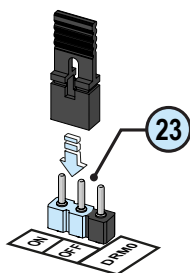

Where requested by the AS/NZS 4777 standard, it's possible to use the REM terminal block ②⑥ for the Demand Responce Mode 0 (DRM0) functionality. The function could be activated by placing the provided jumper ②③ in “ON” position.

In case of the DRM0 function is activated without the proper wiring of the REM terminal block ②⑥, the inverter will no longer be able to connect to the grid. For further information regarding the DRM0 function refer to the AS/NZS 4777 standard.



Configurable Relay connection (ALARM / LOAD MANAGER)

The UNO-DM-COM KIT board is equipped with a relay with configurable activation that allows connection of external devices which for example, signal malfunctions to manage loads with a specific configurable power input threshold, according to the mode selected in the specific section of internal webserver (see the specific chapter) or in the display menu “INVERTER > SETTINGS > ALARMS > SET ALARM TYPE”. The connection must be made to the specific ALARM terminal block ④.

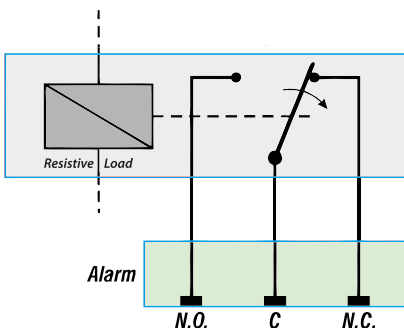
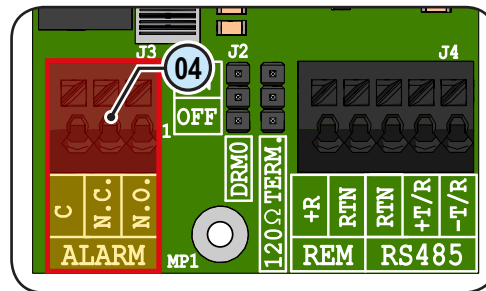

The configurable relay can be used with normally open contact (being connected between the NO terminal and the common contact C) and with normally closed contact (being connected between the NC terminal and the common contact C).

Different types of devices (light, sound, etc.) can be connected to the relay, provided they comply with the following requirements:

Relay Rating:

Maximum Voltage: 230 Vac

Maximum Current: 1 A

The cable specifications are described in the following table:

AWG	Operating voltage	Operating temperature
22 - 24	≥300 V	-20...+60 °C

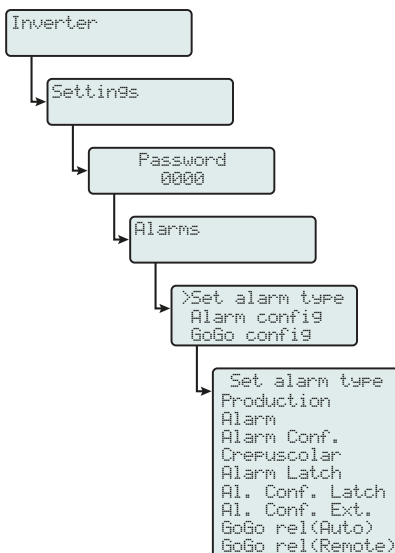

This contact can be used in different operating configurations that can be selected by accessing the specific section of internal webserver (refer to the specific chapter) or in the dedicated display menu (see side picture).

Connection of the energy meter

With a energy meter the system could automatically manages power flows in order to optimize self-consumption or avoid feeding power to the grid (except during transitory), basing on the reading of the meter.

On the basis of the type of electric supply the following are available:

- REACT-MTR-1PH (54) for single-phase supplies up to 30 A.
- ABB B21 (40) for single-phase supplies up to 65 A.
- ABB B23 (56) for three-phase supplies up to 65 A (it can be used for single-phase supplies if correctly installed).
- ABB B24 (58) for three-phase supplies with an external current transformer (it can be used for single-phase supplies if correctly installed).

The energy meter will communicate with the inverter through the RS485 serial line (26) situated on the Accessory Board (18).



Accessory Board (UNO-DM-COM KIT or UNO-DM-PLUS-COM Ethernet KIT (18)) is required for energy meter proper working.



The meter must always be protected by fuses or circuit breakers on the incoming side. It is recommended that the input voltage sensing is protected by fuses rated 6A (gL-gG type) or by circuit breakers rated 6A (B/C type) installed near the meter.



Once the meter is installed in the plant it will be required to set the proper parameters during the wizard procedure in commissioning phase, or in the dedicated section of internal webserver, in order to allow the proper working of energy meter and to enable the Dynamic Feed-in control functionality (refer to relevant section of this user manual).



Connection of the REACT-MTR-1PH (single-phase)



The indications set out below are necessary to connect the REACT-MTR-1PH to the inverter. Always refer to the specific documentation supplied with the REACT-MTR-1PH.

The energy meter REACT-MTR-1PH (54) is a DIN rail device (3 modules) and must be installed where the electricity supply is single-phase.



To avoid risks of electrical shock, all wiring operations must be carried out with the AC disconnect switch (or the supply meter) upstream of the REACT-MTR-1PH disconnected.

- Ensure that the AC line has been correctly disconnected upstream from the REACT-MTR-1PH. Check that there is no voltage by using a multimeter.
- Strip 8/10mm of sheathing from the connection cables of the AC power supply and connect the phase (L) and neutral (N) on the specific terminal block (56) set on the upper side of the meter; each individual terminal of the terminal block takes a cable with a maximum section from 0.5 to 4mm² (tightening torque of 0.5Nm).
- Connect the cables of the serial line (+T, -T and RTN) on the terminal block (57) on the lower part of the REACT-MTR-1PH. Each individual terminal of the terminal block takes a cable with a section from 0.14 to 1.5mm² (tightening torque of 0.5Nm).

Subsequently the cable must be connected inside the inverter on the Accessory Board (18) respecting the correspondence between the signals of the serial line.

Serial line terminal block of the REACT-MTR-1PH (57)	Communication and control signal terminal block (26) of the Accessory Board (18)
+T	+T/R
-T	-T/R
RTN	RTN



To connect the serial cable inside the inverter, refer to the section “Connection of the RS485 line” in this chapter.

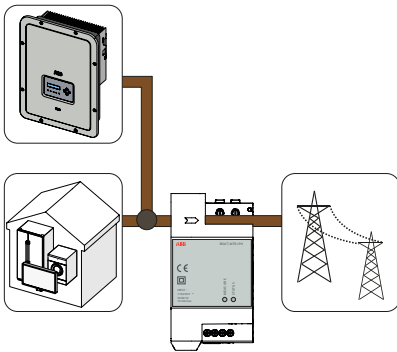

- Install the device on the DIN rail and ensure to trigger the fixing system on it
- Disconnect the phase cable (L) of the electric supply
- Insert the phase cable (L) through the hole (Ø8mm) on the REACT-MTR-1PH (54). The arrow corresponding to the hole for the feeding of the line cable (55), indicates the direction of insertion which must be complied with for correct measurement of the current; in fact the direction of the arrow indicates the supply point of the electric energy (as indicated in the diagram).
- Once the connection stage is finished, the correct installation of the REACT-MTR-1PH must be verified (54):
 - Power the REACT-MTR-1PH while keeping the inverter off
 - Action a load (of at least 50W) in the house so that the REACT-MTR-1PH records drawing of current from the grid
 - Check that the LED STATUS (red) is permanently on. This condition indicates that a drawing from the grid is recorded and so that the reading of the direction of the current by the REACT-MTR-1PH is correct.

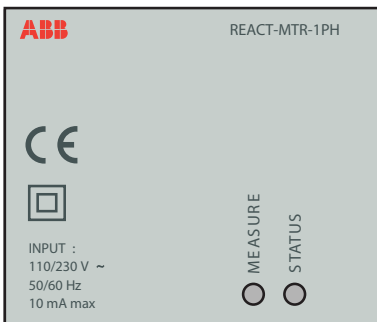

Here below is set out the behaviour of LEDs on the REACT-MTR-1PH:

MEASURE LED	description
Permanent Green	Serial communication absent or malfunctioning
Flashing	Serial communication present

STATUS LED	description
Permanent red	Drawing of energy from the grid
Green (steady)	Self-consumption (maximum exchange ±20W)
Flashing red and green	Feeding energy to the grid

Connection and configuration of the ABB B21 meter (single-phase)



The indications set out below are necessary to connect the meter to the inverter. Always refer to the specific documentation supplied with the ABB B21.

The energy meter ABB B21 (40) is a DIN rail device (2 modules) and must be installed where the electricity supply is single-phase.



To avoid risks of electrical shock, all wiring operations must be carried out with the AC disconnect switch (or the supply meter) upstream of the meter disconnected.

- Disconnect the AC disconnect switch upstream of the meter.
- Strip the insulation of the cable for the length which is indicated on the meter (13mm).
- Connect the cables of the single-phase line in accordance with the layout printed on the meter (L and N) to the AC connection terminal block (56) and tighten the screws (tightening torque 3.0 Nm).

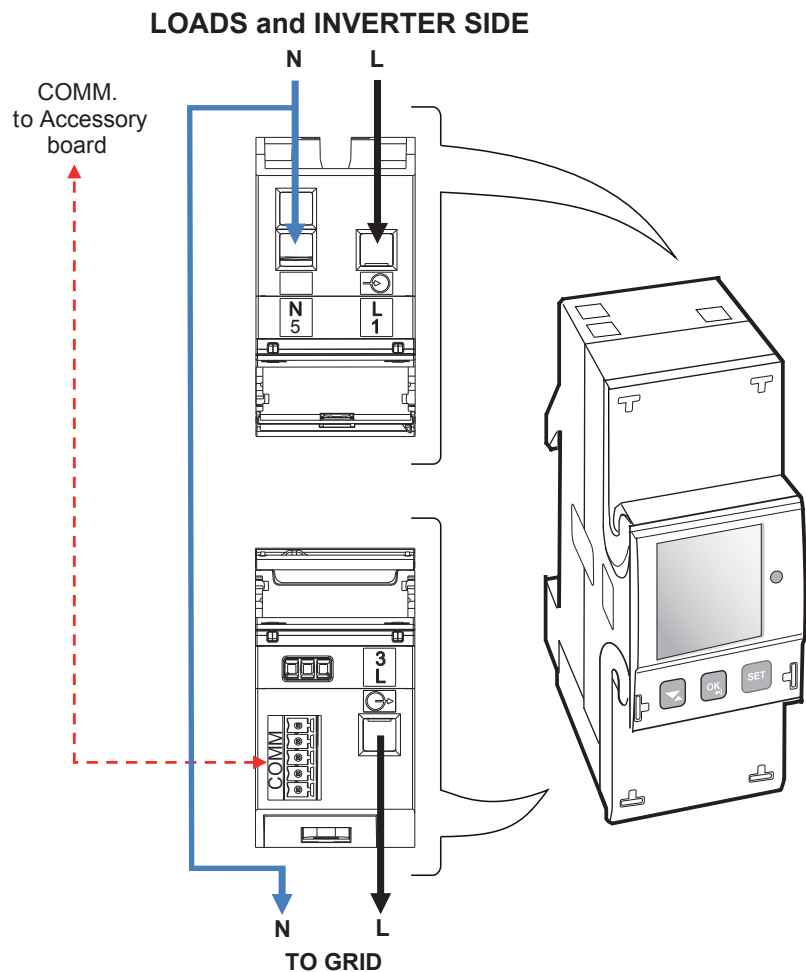

- Connect the cables of the serial line A (37), B (36) and C (37) on the terminal block (57) set on the rear of the ABB B21 (40) and tighten the screws (tightening torque 0.25 Nm).

Subsequently the cable must be connected inside the inverter on the Accessory Board (18) respecting the correspondence between the signals of the serial line.

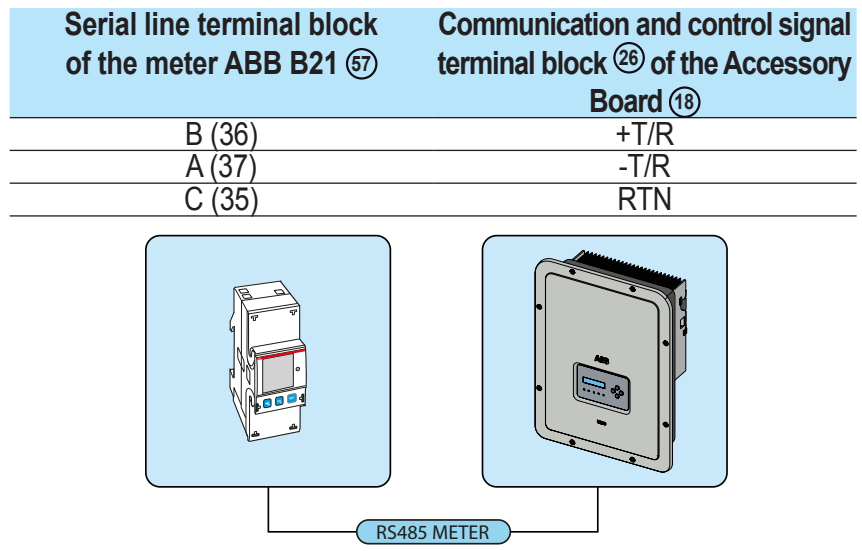





























To connect the serial cable inside the inverter, refer to the section “Connection of the RS485 line” in this chapter.

- Install the device on the DIN rail and ensure to trigger the fixing system on it
- Once the phase of mechanical installation of the METER is finished, it is necessary to configure the METER in order to make it compatible with the inverter. Set the parameters of the meter as set out in the table:

Parameter	Settings
Address	1
Protocol	MODBUS
Baud rate	19200
Parity	EVEN

The settings are made by using the keypad and the display on the meter:

1. Press for two seconds  to access the setup menu of the meter.
2. Press repeatedly  until the display shows “Set”.
 - Press  to confirm.
3. Press repeatedly  until the display shows “RS-485”.
 - Press  to confirm.
4. Press repeatedly  until the display shows “Prot”.
 - Press  to access.
 - Press  to enable the change in the value.
 - Press repeatedly  until the display shows “Modbus”.
 - Press  to confirm the change.
 - Press for two seconds  to return to the RS485 menu.
5. Press repeatedly  until the display shows “Baud”.
 - Press  to access.
 - Press  to enable the change in the value.
 - Press repeatedly  and select 19200.
 - Press  to confirm the change.
 - Press for two seconds  to return to the RS485 menu.
6. Press repeatedly  until the display shows “Address”.
 - Press  to access.
 - Press  to enable the change in the value.
 - Press repeatedly  and select 1.
 - Press  to confirm the change.
 - Press for two seconds  to return to the RS485 menu.
7. Press repeatedly  until the display shows “Parity”.
 - Press  to access.
 - Press  to enable the change in the value.
 - Press repeatedly  and select even.
 - Press  to confirm the change.



Connection and configuration of the ABB B23, B24 3PH (three-phase)



The indications set out below are necessary to connect the meter to the inverter. Always refer to the specific documentation supplied with the ABB B23 or B24 3PH meter.

The energy meter ABB B23, B24 3PH (58) is a DIN rail device (4 modules) and must be installed where the electricity supply is three-phase.



To avoid risks of electrical shock, all wiring operations must be carried out with the AC disconnect switch (or the supply meter) disconnected upstream of the meter.

- Disconnect the AC disconnect switch upstream of the meter.
- Strip the insulation of the cable for the length which is indicated on the meter (13mm).
- Connect the cables of the three-phase line in accordance with the layout printed on the meter (L1, L2, L3 and N) to the three-phase connection terminal block (59) and tighten the screws (tightening torque 2.0 Nm).

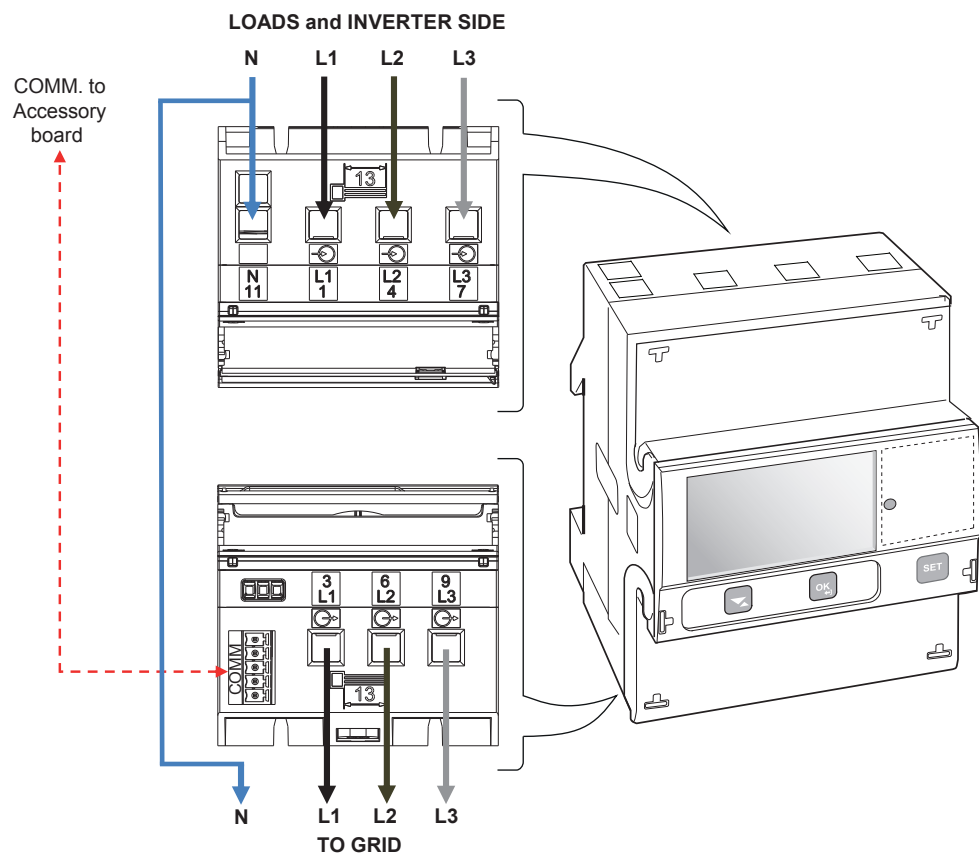

Take note of the phase to which the inverter is connected; this information will be requested when the system is commissioned.



It's possible to use the three-phase meter ABB B23, B24 as a single-phase meter. To use the ABB B23, B24 as a single-phase meter connect it as follows:

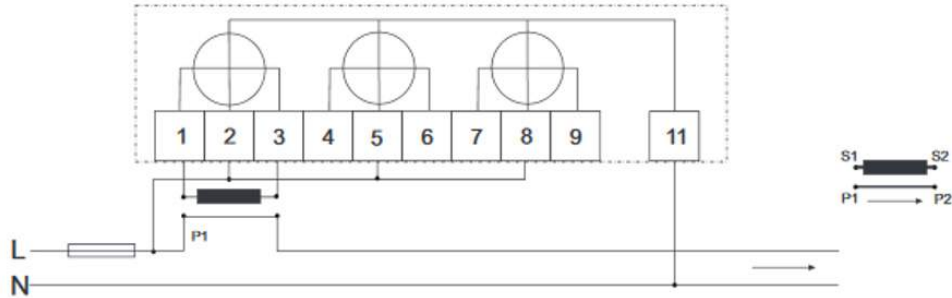

- Connect the cables of the serial line A (37), B (36) and C (37) on the terminal block 60 set on the rear of the ABB B23, B24 3PH 58 and tighten the screws (tightening torque 0.25 Nm).

Subsequently the cable must be connected inside the inverter on the Accessory Board 18 respecting the correspondence between the signals of the serial line.



Serial line terminal block of the ABB B23, B24 60	Communication and control signal terminal block 26 of the Accessory Board 18
B (36)	+T/R
A (37)	-T/R
C (35)	RTN

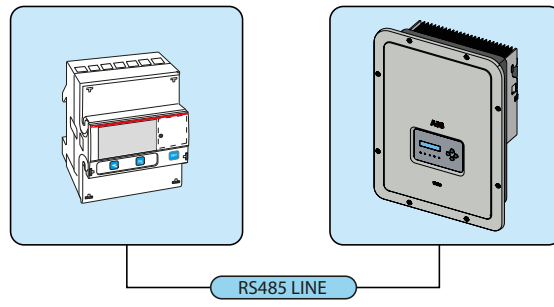





























To connect the serial cable inside the inverter, refer to the section “Connection of the RS485 line” in this chapter.

- Install the device on the DIN rail and ensure to trigger the fixing system on it

- Once the phase of mechanical installation of the METER is finished, it is necessary to configure the METER in order to make it compatible with the inverter. Set the parameters on the meter display as set out in the table:

Parameter	Settings
Address	1
Protocol	MODBUS
Baud rate	19200
Parity	EVEN

The settings are made by using the keypad and the display on the meter:

1. Press for two seconds  to access the setup menu of the meter.
2. Press repeatedly  until the display shows “Set”.
 - Press  to confirm.
3. Press repeatedly  until the display shows “RS-485”.
 - Press  to confirm.
4. Press repeatedly  until the display shows “Prot”.
 - Press  to access.
 - Press  to enable the change in the value.
 - Press repeatedly  until the display shows “Modbus”.
 - Press  to confirm the change.
 - Press for two seconds  to return to the RS485 menu.
5. Press repeatedly  until the display shows “Baud”.
 - Press  to access.
 - Press  to enable the change in the value.
 - Press repeatedly  and select 19200.
 - Press  to confirm the change.
 - Press for two seconds  to return to the RS485 menu.
6. Press repeatedly  until the display shows “Address”.
 - Press  to access.
 - Press  to enable the change in the value.
 - Press repeatedly  and select 1.
 - Press  to confirm the change.
 - Press for two seconds  to return to the RS485 menu.
7. Press repeatedly  until the display shows “Parity”.
 - Press  to access.
 - Press  to enable the change in the value.
 - Press repeatedly  and select even.
 - Press  to confirm the change.

Closing the front cover

At the end of the inverter connection and configuration stage and before proceeding with the commissioning, the inverter's cover ① must be closed.

IP65

During the installation of the cover, the installation sequence must be respected as well as the tightening torque of the 8 screws (set out in the paragraph on technical data) in order to keep the IP level of the inverter unchanged

- Insert and screw in the 8 fixing screws.
- Tighten the screws respecting the sequence and the tightening torque.

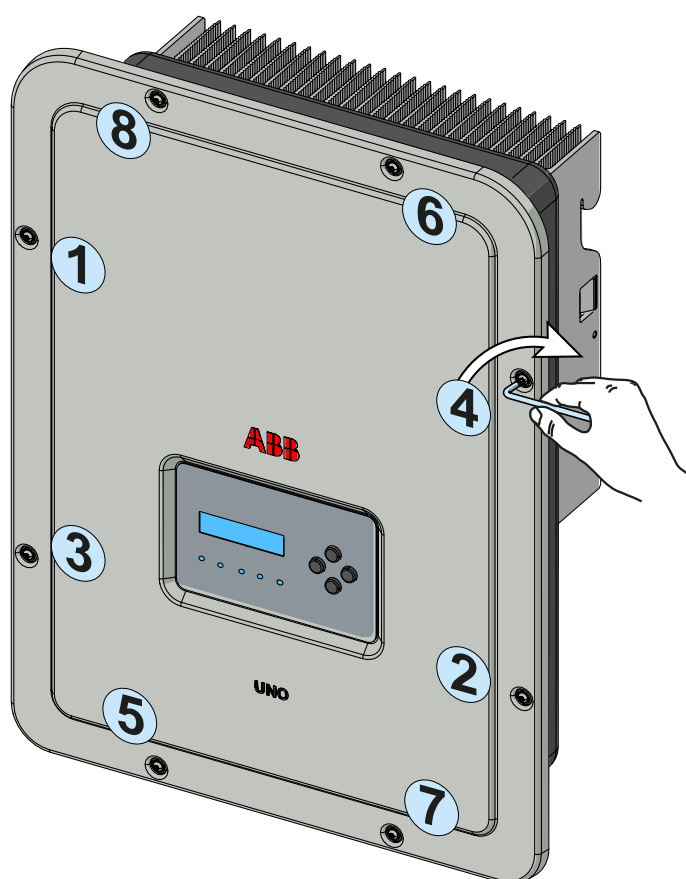

After having installed the front cover, it is possible to proceed with the commissioning of the inverter.

General conditions

One of the first rules for preventing damage to the equipment and to the operator is to have a thorough knowledge of the instruments. We, therefore, advise that you carefully read this manual. If you are not sure about any information in this manual, please ask ABB Service for more detailed information.



Do not use the equipment if:

- *you do not have suitable qualifications to work on this equipment or similar products;*
- *you are unable to understand how it works;*
- *you are not sure what will happen when the buttons or switches are operated;*
- *you notice any operating anomalies;*
- *there are doubts or contradictions between your experience, the manual and/or other operators.*

ABB cannot be held responsible for damage to the equipment or the operator if it is the result of lack of knowledge, insufficient qualifications or lack of training.

Description of keyboard and LED Panel

Using the combination of the keyboard keys below the display, values can be set or data can be viewed by scrolling.

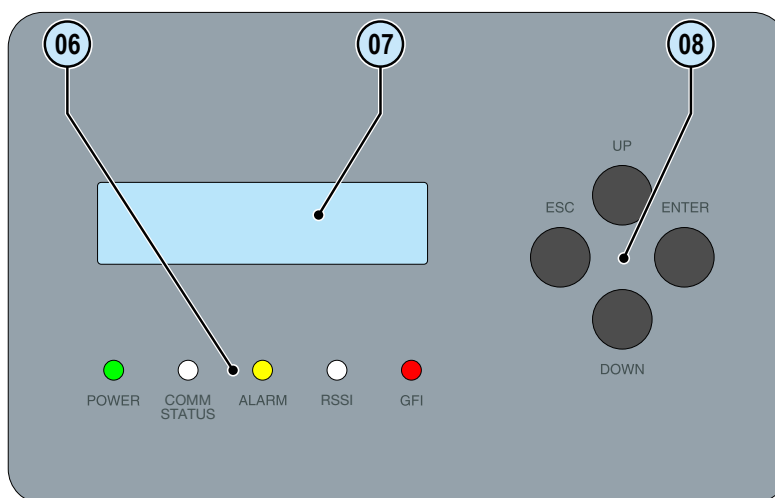

LED	Description
POWER (GREEN)	On if the inverter is working correctly. Flashes when checking the grid or if there is insufficient sunlight.
COMM STATUS (MULTICOLOR)	Operation status of wireless communication line: Blink Red: Communication error (no communication available) Green: Communication OK
ALARM (YELLOW)	The inverter has detected an anomaly. The anomaly is shown on the display.
RSSI (MULTICOLOR)	Communication type and quality of the wireless communication signal (for "Station Mode"): Blink Blue: Wireless board is working in Access Point mode (AP Mode) OFF: No signal Blink Red: Low signal strength Blink Yellow: Medium signal strength Blink Green: High signal strength
GFI (RED)	Ground fault on the DC side of the PV generator. The error is shown on the display.

The LEDs, in various multiple available combinations, can signal multiple conditions other than the original single condition; see the various descriptions explained in the manual.

Button	Description
ESC	It is used to access the main menu in order to go back to the previous menu or to go back to the previous digit to be edited.
UP	It is used to scroll up the menu options or to scroll through the numerical scale in ascending order.
DOWN	It is used to scroll down the menu options or to scroll through the numerical scale in descending order.
ENTER	It can be used to confirm an action, to access the main menu or the submenu for the selected option (indicated by the > symbol) or to switch to the next digit to be edited. When the ENTER key is pressed, cyclic display of the parameters can be: Blocked or Cyclical .

The Keys, in various multiple available combinations, allow you to access actions other than the original single action; see the various descriptions explained in the manual.

General conditions

Before checking the operation of the equipment, it is necessary to have a thorough knowledge of the Instruments chapter 6 and the functions that have been enabled in the installation process.

The equipment operates automatically without the aid of an operator; the operating state should be controlled through the equipment's instrumentation.

The interpretation or variation of some data is reserved exclusively for specialized and qualified staff.



*The input voltage must not exceed the maximum values shown in the technical data, section 2 in order to avoid damaging the equipment.
Consult the technical data for further details.*

During operation, check that the environmental and storage conditions are correct (see installation chapter 5).

Make sure that environmental and storage conditions have not changed over time and that the equipment is not exposed to adverse weather conditions.

Monitoring and data transmission

User interface

The inverter is able to provide information about its operation through the following instruments:

- Warning lights (luminous LEDs)
- LCD display showing operating data
- Mobile app and webserver
- Data transmission on the dedicated RS-485 serial line. The data can be collected by a PC or a data logger equipped with an RS-485 port. Contact the ABB support service with any queries about device compatibility.

Measurement tolerance

The data supplied by the inverter may differ from measurements taken by certified measuring instruments (e.g. output meters, multimeters and grid analysers); since the inverter is not a measuring instrument it has wider tolerances for the measurements it makes.

The tolerances are generally:

±5% for real-time measurements with output power below 20%

±3% for real-time measurements with output power above 20%

±4% for all statistical data.



Commissioning (Via internal Webserver)



Do not place objects of any kind on the inverter during operation! Do not touch the heat sink while the inverter is operating! Some parts may be very hot and could cause burns.



Before proceeding with commissioning, make sure you have carried out all the checks and verifications indicated in the section on preliminary checks.

Commissioning could be carried out via wireless connection to the inverter's internal webserver. Initial setup of the system must therefore be carried out via a tablet, notebook or smartphone with a wireless connection.

- Close the DC disconnect switch to supply the inverter with input voltage from the photovoltaic generator.



Make sure irradiation is stable and adequate for the inverter commissioning procedure to be completed.

- Once powered, the inverter will automatically create a wireless network (approx. 60 seconds after its switch-on) that will be visible as an Access Point from the user devices previously mentioned (tablet, smartphone, etc.).

- Enable the wireless connection on the device which is being used for the board setup (tablet, smartphone or PC) and connect it to the Access Point created by the inverter system: the name of the wireless network created by the system that the connection should be established with, will be:

ABB-XX-XX-XX-XX-XX-XX

where "X" is a hex digit of the wireless MAC address (MAC address can be found on the "Wireless Identification Label" placed on the side of the inverter or applied during the commissioning phase to the quick installation guide on cover page).



The screens shown below pertain to a tablet with the Android operating system. Screens on other devices or operating systems may differ.



- When prompted, type the "product key" (including the dashes. Example: 1234-1234-1234-1234) as the network password to access the inverter's access point. The product key is printed on the "wireless identification label" on the side of the inverter.

- Open an internet browser (reccomended browser: Chrome versions from v.55, Firefox versions from v.50) and enter the pre-set IP address **192.168.117.1** to access the setup pages (web user interface). A guided setup procedure will open that will enable you to impose the necessary settings for correct commissioning of the inverter.



The language of the wizard could be changed by clicking on the upper status bar

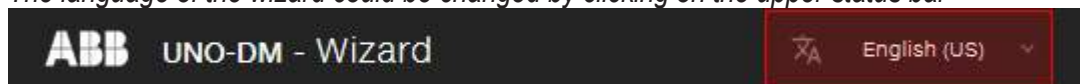

The required informations during the procedure are:

STEP 1 - Administrator/User login credentials

Administrator account

Admin ⓘ

Username

Required

Password ⓘ

Password

Required

Confirm Password ⓘ

Re-enter Password

Required

User account

User ⓘ

Username

Required

No user password

NEXT

- Set the **Administrator** account user and password (minimum 8 character for password):

Administrator account can open and view the contents of photovoltaic site. Additionally, they can make changes to inverter settings. User and password are CASE SENSITIVE.

- Set the **User** account user and (optional) password (minimum 8 character for password):

User account can only read data. It cannot make any changes. User and password are CASE SENSITIVE.



STEP 2 (Optional) - Residential wireless network connection.

The inverter WLAN board can operate in two different operating modes: “Station Mode” or “Access Point Mode” (also known as “AP Mode”)

- “AP mode”: Only local communication is enabled in this mode; In particular, the WLAN board acts like an «access point» generating a wireless network to which the user can connect locally, to monitor or configure the inverter / photovoltaic system, using the direct access to the Internal Webserver integrated in the WLAN board

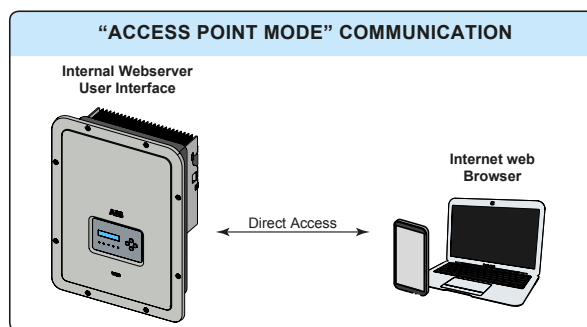

- “Station Mode”: In this operating mode, not only local but also remote monitoring is enabled through access to the LAN connection or through the Aurora Vision® CLOUD platform.

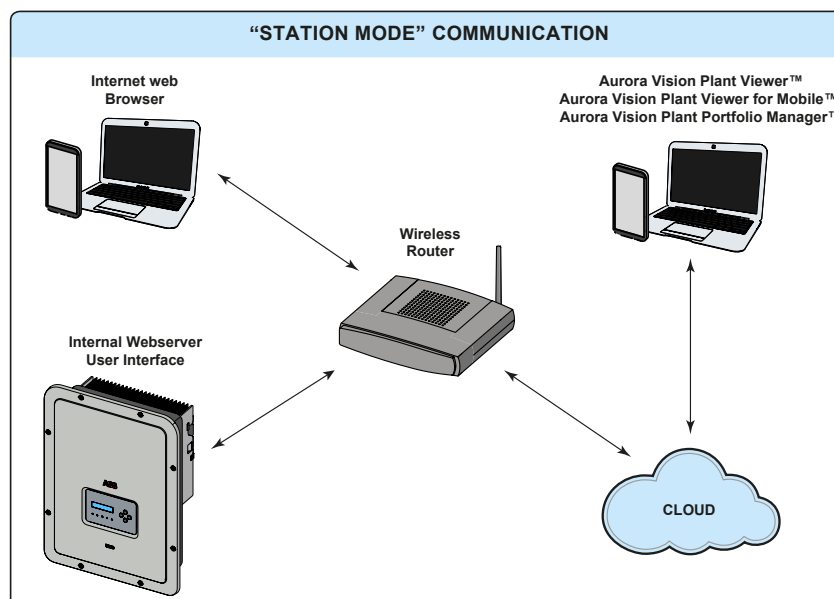

Where possible, connecting the inverter in “Station Mode” is always preferable. Thanks to the internet connection, this mode ensures better operation.

This setup stage relates to connecting the inverter to the own residential wireless network.

If it is not possible to connect the inverter to the wireless network, or you do not want to do so, select the “Skip this step” button. In this situation, communication between the inverter and the tablet/smartphone/PC can be only performed with a point to point (“AP Mode”) connection.

Wireless Network

Skip this step

IP Settings

DHCP

Available Network (SSID)

-- Please select --

Required

Password

Show password

CONNECT

The parameters relating to the home wireless network (set on the router) that must be known and set during this step are:

- IP Settings: DHCP or Static.

If you select the DHCP function (default setup) the router will automatically assign a dynamic IP address to the inverter whenever it tries to connect to the user network.

With Static, the user can assign a fixed IP address to the system. The data which has to be entered in order for IP static address assigning to take place will appear. Complete the additional fields at the bottom of the screen (all the fields are mandatory with the exception of the secondary DNS server).

- Available networks (SSID):

Identify and select your own (home) wireless network from all those shown in the SSID field (you can carry out a new search of the networks that can be detected with the Update button).

Once the network has been selected, confirm.

- Password: Wireless network password.

Enter the password for the destination network (if necessary) and start the connection attempt (it will take a few seconds).

Click on “Connect” button to connect the inverter to the home wireless network.



Wireless network connection:

Home_Network

The inverter is going to be connected to the wireless network **Home_Network**

On-going attempt to connect to the wireless network **Home_Network**

Back Next

A message will ask for confirmation. Click “Next” to connect the inverter to the home wireless network.

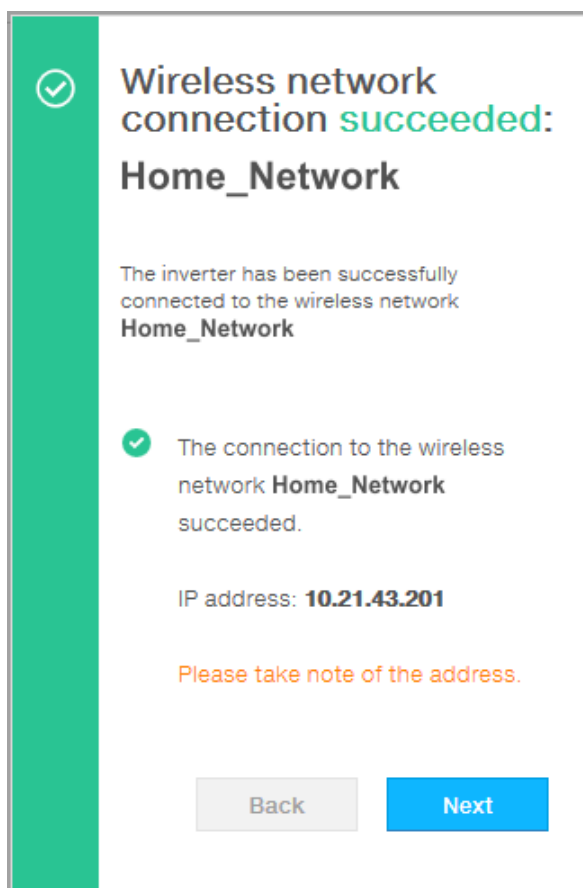

Once the inverter is connected to the domestic wireless network, a new message will confirm that the connection is acquired.

The message provides the IP Address assigned by the home wireless network router to the inverter that can be used each time you want to access the internal webserver, with the inverter connected to the home wireless network. **Take note of it.**

Click on “Next” button to proceed to the next stage of the configuration wizard.



The IP address assigned may vary for reasons connected to the wireless home router setup (for example, a very brief DHCP lease time). If verification of the address is required, it is usually possible to obtain the client list (and the corresponding IP addresses) from the wireless router administration panel.

If the inverter loses the connection with the home wireless network (and therefore, loses the internet connection), it will once again enable its own access point.



The most common causes of losing connectivity might be: different wireless network password, faulty or unreachable router, replacement of router (different SSID) without the necessary setting updates.

STEP 3 - Date, Time and Time zone

Date and Time

✔ Network Time Protocol server has been detected and it will be used to keep the system clock synchronized.

Date

Feb 22, 2017

SET by the NTP server

Time

3:28 PM

SET by the NTP server

Time Zone

Europe/Berlin GMT+01:00

BACK NEXT

Set the Date, Time and Time zone (The inverter will propose these fields when available).

Date and Time

⊙ Network Time Protocol server has not been detected. Clock isn't synchronized. The displayed date and time come from the inverter or have been manually set up.

Please set the correct system date and time if needed.

Date and time will be automatically updated as soon an NTP server is available.

Date

2/8/17

Time

11 : 56 AM

Time Zone

Europe/Berlin GMT+01:00

BACK NEXT

When it's not possible for the inverter to detect the time protocol, these fields have to be manually entered.

Click on "Next" button to proceed to the next stage of the configuration wizard.

STEP 4 - Inverter country standard, Input configuration and Meter configuration (Dynamic Feed-in Control)

- Country standard: selection of grid standard:

Set the grid standard of the country in which the inverter is installed.



From the moment that the grid standard is set, you have 24 hours to make any changes to the value, after which the “Country Select > Set Std.” functionality is blocked, and the remaining time will have to be reset in order to have the 24 hours of operation available again in which to select a new grid standard (follow the procedure “Resetting the remaining time for grid standard variation” described in the relevant section).

The screenshot shows a configuration screen with three main sections:

- Country standard:** A dropdown menu labeled 'Grid Standard' with the text '-- Please select --' and a red border. Below it, the word 'Required' is written in red.
- Input mode:** A dropdown menu labeled 'PV Input Channels Configuration' with the text 'Independent'.
- Meter:** A dropdown menu labeled 'Meter Model' with the text 'none'.

At the bottom of the screen, there are two buttons: 'BACK' (blue) and 'END' (light blue).

- Input mode:

(See the relevant section of this manual to know how set the input mode)

1. **Independent**
2. **Parallel**

- Meter:

When a meter device is connected to the inverter, it's requested to select the meter model:

1. **None** (where system is installed without meter)
2. **REACT-MTR-1PH** (single-phase)
3. **ABB 1PH** (single-phase)
4. **ABB 3PH** (three-phase)



If a 3PH energy meter (ABB B23, B24) is used in the system as single-phase inverter, it will be necessary to select **ABB 3PH** and the phase to which the inverter is connected.

Meter

Meter Model

ABB B23 3PH

Meter Phase

Phase L1

Energy Policy

Energy Policy

Self consumption

PV Generator Power (kWp)

0

Feed-In Power (% Of PV Generator Power)

100

ⓘ After country standard is changed the inverter will be rebooted. The procedure may take up to **5 minutes**.

BACK

END

Once the meter model is selected, additional requested fields will appear:

- **METER PHASE:** If the METER is three-phase, the phase to which the inverter is connected must be selected. (This field will appear only if you select the ABB B23 3PH meter model)
- **ENERGY POLICY:** set the way in which you want to manage the energy produced by the PV plant, choosing from the following:

Management mode	Description
Self consumption	The system automatically manages power flows in order to maximise self-consumption. All unused power from domestic loads will feed into the grid.
Zero injection	The system automatically manages power flows in order to avoid the injection of energy to the grid. If the meter is disconnected or not working the inverter's output power is restricted to zero in order to avoid accidental power feeding to the grid.
Configurable	The system automatically manages power flows in order to avoid feeding the grid with power greater than: $P_{DC} \times P_{lim}$ where P_{DC} is the power of the photovoltaic generator ("PV GENERATOR POWER" parameter) and P_{lim} is the output power limit with respect to $P_{DC}(\%)$ ("FEED-IN POWER" parameter).



Saving parameters

ⓘ After country standard is changed the inverter will be rebooted. The procedure may take several minutes. Please wait.

BACK

END

- **PV GENERATOR POWER:** Insert the power value of the photovoltaic system (kWp) installed.
- **FEED-IN POWER:** Set the percentage AC power restriction (with reference to the value of the photovoltaic system (kWp) installed) to be feed into the grid. This field can be edited only if the Energy Policy selected is "Configurable".

Confirm the settings by clicking "END" and the inverter will test the meter working (if selected a meter device) and it will reboot at the finish of test phase.

A notification will confirm that the wizard is completed.

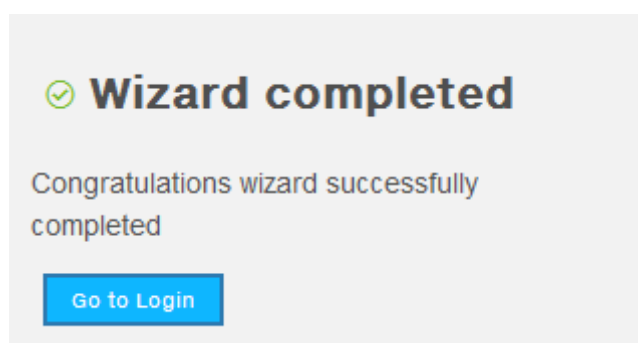

• After the wizard is completed, the message “Initializing...Please Wait” is displayed on the inverter display. Regardless of the input voltage value, the inverter displays various messages and changes the behaviour of the “Power” and “Alarm” LEDs .

Input voltage	Message on display	LED Status	Description
$V_{in} < V_{start}$	Waiting Sun	Power = Flashing Alarm = OFF	The input voltage is not sufficient to enable connection to the grid.
$V_{in} > V_{start}$	Missing Grid	Power = Flashing Alarm = ON	The input voltage is sufficient to enable connection to the grid: the inverter waits for the grid voltage to be present to make the parallel connection.



The inverter is powered SOLELY by the voltage generated by the photovoltaic generator: the presence of grid voltage alone is NOT SUFFICIENT for the inverter to switch on.

• With the inverter in the “Missing Grid” status, close the AC switch downstream of the inverter thus applying the grid voltage to the inverter: the inverter checks the grid voltage, measures the insulation resistance of the photovoltaic field with respect to ground and performs other auto-diagnostic checks. During the preliminary checks on the parallel connection with the grid, the “Power” LED keeps flashing, the “Alarm” and “GFI” LEDs are off.

• During the check on the grid voltage and the measurement of the insulation resistance, the voltage, grid frequency and insulation resistance values measured by the inverter are displayed. The inverter ONLY creates a parallel connection with the grid if the grid and insulation resistance parameters fall within the ranges foreseen by current regulations.

• If the outcome of the preliminary checks on the grid parallel is positive, the inverter connects to the grid and starts to export power to the grid. The “Power” LED remains fixed on while the “Alarm” and “GFI” LEDs are off.

To address any problems that may occur during the initial stages of operation of the system and to ensure the inverter remains fully functional, you are advised to check for any firmware updates in the download area of the website www.abb.com/solarinverters or at <https://registration.abbsolarinverters.com> (instructions for registering on the website and updating the firmware are given in this manual).



Commissioning (Using the inverter display)



Do not place objects of any kind on the inverter during operation! Do not touch the heat sink while the inverter is operating! Some parts may be very hot and could cause burns.



Before proceeding with commissioning, make sure you have carried out all the checks and verifications indicated in the section on preliminary checks.

The procedure for commissioning the inverter consists of the following steps:

- Close the DC disconnect switch to supply the inverter with the photovoltaic generator voltage.

If the inverter is equipped with a DC disconnect switch (-S models), set the DC disconnect switch  to the ON position.

- When the inverter is connected to the power supply, the display will show a guided configuration procedure and the yellow ALARM led is fast blinking. Press ENTER to set the following:

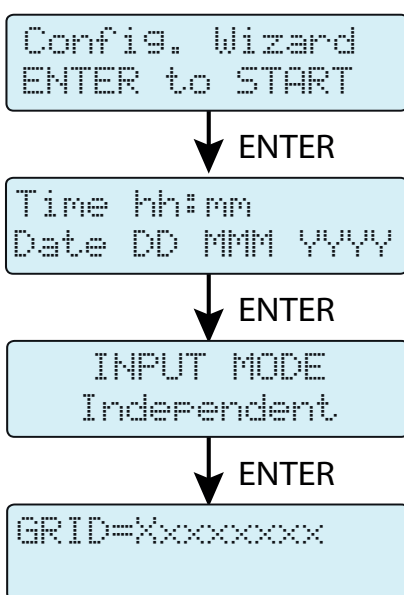

- Inverter date and time

- Selection of the current input mode: Independent or Parallel (See the relevant section of this manual to know how to set the proper input mode)

- Selection of grid standard (and corresponding display language).



For the list of available grid standards and the relative details, contact ABB.



From the moment that the grid standard is set, you have 24 hours to make any changes to the value, after which the "System > Settings > Country Select > Set Std." functionality is blocked, and the remaining time will have to be reset in order to have the 24 hours of operation available again in which to select a new grid standard (follow the procedure "Resetting the remaining time for grid standard variation" described in the relevant section).

- After having set the Country Standard (grid standard), the message "Initializing...Please Wait" is displayed. Regardless of the input voltage value, the inverter displays various messages and changes the behaviour of the "Power" and "Alarm" LEDs :

Input voltage	Message on display	LED Status	Description
$V_{in} < V_{start}$	Waiting Sun	Power = Flashing Alarm = OFF	The input voltage is not sufficient to enable connection to the grid.
$V_{in} > V_{start}$	Missing Grid	Power = Flashing Alarm = ON	The input voltage is sufficient to enable connection to the grid: the inverter waits for the grid voltage to be present to make the parallel connection.



The inverter is powered SOLELY by the voltage generated by the photovoltaic generator: the presence of grid voltage alone is NOT SUFFICIENT for the inverter to switch on.

- With the inverter in the "Missing Grid" status, close the AC switch downstream of the inverter thus applying the grid voltage to the inverter: the inverter checks the grid voltage, measures the insulation resistance of the photovoltaic field with respect to ground and performs other auto-diagnostic checks. During the preliminary checks on the parallel connection with the grid, the "Power" LED keeps flashing, the "Alarm" and "GFI" LEDs are off.
- During the check on the grid voltage and the measurement of the insulation resistance, the voltage, grid frequency and insulation resistance values measured by the inverter are displayed. The inverter ONLY creates a parallel connection with the grid if the grid and insulation resistance parameters fall within the ranges foreseen by current regulations.
- If the outcome of the preliminary checks on the grid parallel is positive, the inverter connects to the grid and starts to export power to the grid. The "Power" LED remains fixed on while the "Alarm" and "GFI" LEDs are off.































To address any problems that may occur during the initial stages of operation of the system and to ensure the inverter remains fully functional, you are advised to check for any firmware updates in the download area of the website www.abb.com/solarinverters or at <https://registration.abbsolarinverters.com> (instructions for registering on the website and updating the firmware are given in this manual).



Power, Alarm, GFI LEDs behaviour

The following table shows all the possible activation combinations of “Power” “Alarm” and “GFI” LEDs on the LED panel  according to the operating status of the inverter.

-  = LED On
-  = LED flashing
-  = LED Off
-  = Anyone of the conditions described above

LED status	Operating state
Power:  Alarm:  GFI: 	Firmware programming The inverter firmware is being programmed
Power:  Alarm:  GFI: 	Night mode (inverter automatically switches off) The inverter is in night time switch-off mode (input voltage less than 70% of the set start-up voltage).
Power:  Alarm:  GFI: 	Inverter initialisation This is a transitional state due to the verification of the operating conditions. During this stage the inverter checks that the conditions for connecting to the grid are met.
Power:  Alarm:  GFI: 	The inverter is connected and is feeding power into the grid Normal operation. During this stage, the inverter automatically tracks and analyses the photovoltaic generator's maximum power point (MPP).
Power:  Alarm:  GFI: 	Disconnection from the grid Indicates no grid voltage. This condition does not allow the inverter to connect to the grid (the inverter display shows the message "Missing Grid").
Power:  Alarm:  GFI: 	Indication of Warning (W message codes) or Error (E message codes) Indicates that the inverter control system has detected a warning (W) or error (E). The display shows a message indicating the type of problem found (see Alarm messages).
	<ul style="list-style-type: none"> • Ventilation anomaly Indicates an anomaly in the operation of the internal ventilation system that could limit output power at high ambient temperatures.
	<ul style="list-style-type: none"> • Failed association of internal inverter components (after replacement) Indicates that the installed wiring box (only in the event of a replacement) was already associated with another inverter and cannot be associated with the new inverter
Power:  Alarm:  GFI: 	<ul style="list-style-type: none"> • Overvoltage surge arresters triggered (where fitted) Indicates that any class II overvoltage surge arresters installed on the AC or DC side have been triggered
	<ul style="list-style-type: none"> • String protection fuses triggered (where fitted) Indicates that one or more input string protection fuses that may be installed have been triggered
	<ul style="list-style-type: none"> • Autotest (for Italian grid standards only) The inverter is performing an Autotest
Power:  Alarm:  GFI: 	Anomaly in the insulation system of the photovoltaic generator Indicates that a leakage to ground from the PV generator has been detected, causing the inverter to disconnect from the grid.



Specifications on operation of the LEDs

In correspondence to each status of the inverter indicated by the constant or intermittent lighting of the specific LED, the display ⑦ also shows a message identifying the operation which is being carried out or the defect/anomaly recorded (see specific chapter).



In the case of malfunction it is extremely dangerous to intervene personally to try and eliminate the defect. The instructions below must be followed scrupulously; if you do not have the necessary experience and training to intervene safely, please contact a specialist.

LED insulation fault

Interventions after warning of insulation fault

When the GFI LED comes on, first try to reset the warning by pressing the multi-function ESC button on the keyboard ⑧. Should the inverter reconnect normally to the grid, the fault was due to temporary phenomena.



You are advised to have the plant inspected by the installer or a specialist should this malfunction occur repeatedly.

Should the inverter not reconnect to the grid, isolate it on both the AC and DC sides (by using the disconnect switches), then contact the installer or authorised centre to repair the fault in the photovoltaic generator.



COMM Status, RSSI LEDs behaviour

The following table shows all the possible status of “COMM Status” and “RSSI” LEDs on the LED panel ⑥ according to the operating status of the wireless board.

LED	Description
COMM STATUS (MULTICOLOR)	<p>Operation status of wireless communication line:</p> <p>Blink Red: Communication error (no communication available)</p> <p>Green: Communication OK</p>
RSSI (MULTICOLOR)	<p>Communication type and quality of the wireless communication signal (for “Station Mode”):</p> <p>Blink Blue: Wireless board is working in Access Point mode (AP Mode)</p> <p>OFF: No signal</p> <p>Blink Red: Low signal strength</p> <p>Blink Yellow: Medium signal strength</p> <p>Blink Green: High signal strength</p>

Description of the internal Webserver

The UNO-DM-TL-PLUS inverters are equipped with an advanced integrated webserver and user interface that allow a full access to all configuration and commissioning parameters from any electronic device (laptop, tablet and smartphone).



The screenshots shown in this chapter are indicatives and it could be changed without any notification.

Access to the internal Webserver

To access to the internal webserver is required to connect a device equipped with wireless connection (such as tablet, laptop or smartphone).

Depending on completion of STEP #2 of the wizard commissioning phase (the inverter was connected to the domestic wireless network ("Station Mode"), or this step was skipped) it's required to follow one of the two procedures described below:

Connection to the inverter in "Station Mode"

If the inverter was connected to the domestic wireless network, follow this procedures:

- Enable the wireless connection on the device (tablet, smartphone or laptop) and connect it to the same wireless network to which the inverter is connected.
- Open an internet browser (recommened browser: Chrome versions from v.55, Firefox versions from v.50) and enter the IP Address assigned by the router to the inverter, or the "Host Name" (that could be obtained writing this url: **http://ABB-XX-XX-XX-XX-XX-XX.local** replacing the "X" with the hex digits of the wireless MAC address of the inverter (it can be found on the "Wireless Identification Label" placed on the side of the inverter or applied during the commissioning phase to the quick installation guide on cover page)), to access the login page.



*In order to use the "Host Name" as an alternative to the dynamic IP address, the Wi-Fi router to which the board is connected (when operating in "Station Mode") must provide the Domain Name System (DNS) service (contact the network administrator for further information regarding the presence or absence of the DNS service in the Wi-Fi router or how to enable it). In this way, even if the IP address assigned to the inverter should change over time, (dynamic IP), it will always be possible to use the same "Host Name" which will remain unchanged over time. **Android devices doesn't allow the use of "Host Name" to access to the internal webserver!***



The IP address assigned may vary for reasons connected to the wireless home router setup (for example, a very brief DHCP lease time). If verification of the address is required, it is usually possible to obtain the client list (and the corresponding IP addresses) from the wireless router administration panel.



Connection to the inverter in “AP Mode”

If the inverter wasn't connected to the domestic wireless network, follow this procedures:

- Enable the wireless connection on the device which is being used for the board setup (tablet, smartphone or PC) and connect it to the Access Point created by the inverter system: the name of the wireless network created by the system that the connection should be established with, will be:

ABB-XX-XX-XX-XX-XX-XX

where “X” is a hex digit of the wireless MAC address (MAC address can be found on the “Wireless Identification Label” placed on the side of the inverter or applied during the commissioning phase to the quick installation guide on cover page).

- When prompted, type the “product key” (including the dashes. Example: 1234-1234-1234-1234) as the network password to access the inverter's access point. The product key is printed on the “wireless identification label” on the side of the inverter.
- Open an internet browser (reccomended browser: Chrome versions from v.55, Firefox versions from v.50) and enter the pre-set IP address **192.168.117.1** to access the login page.



Login page

After you have connected the device to the inverter and you access to the login page, login with the username and password created during the commissioning phase.



User and password are CASE SENSITIVE.



If the Password is lost click on “Forgot your password?” to obtain the access to the webserver (and it will be possible to change the password) by entering the PRODUCT KEY (printed on the “Wireless identification label” and applied during the commissioning phase to the quick installation guide on cover page).



The language of the internal webserver could be changed in any moment by clicking on the right status bar:



Webserver menu structure



The following screenshots are related from a laptop visualization, may differ from smartphone or tablet visualization.

The Webserver is divided in six main sections, available on the left sidebar:

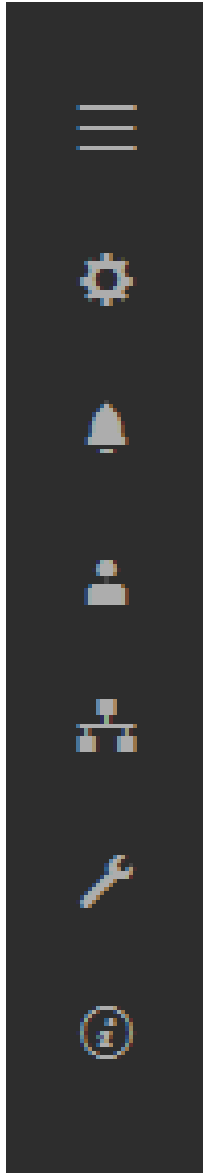

MAIN: Main section of webserver dedicated to viewing the summary informations related the status and the production informations of the inverter and photovoltaic plant.

SETUP: Section dedicated to AC and DC line parameters configurations.

EVENTS: Section dedicated to viewing Alarms and Warnings event log.

USER: Section dedicated to User management.

NETWORK: Section dedicated to inverter communication settings and configurations.

TOOLS: Section dedicated to main service tools configurations.

INFORMATION: Section dedicated for general informations about the embedded webserver.

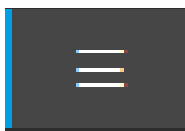

MAIN section

In the **MAIN** section it's possible to access the following sub-menus:

- **Dashboard**
- **Status Summary**

Dashboard

In the **Dashboard** sub-menu you can view the main informations related the status and the production informations of the inverter and photovoltaic plant and alarm/warning active events.

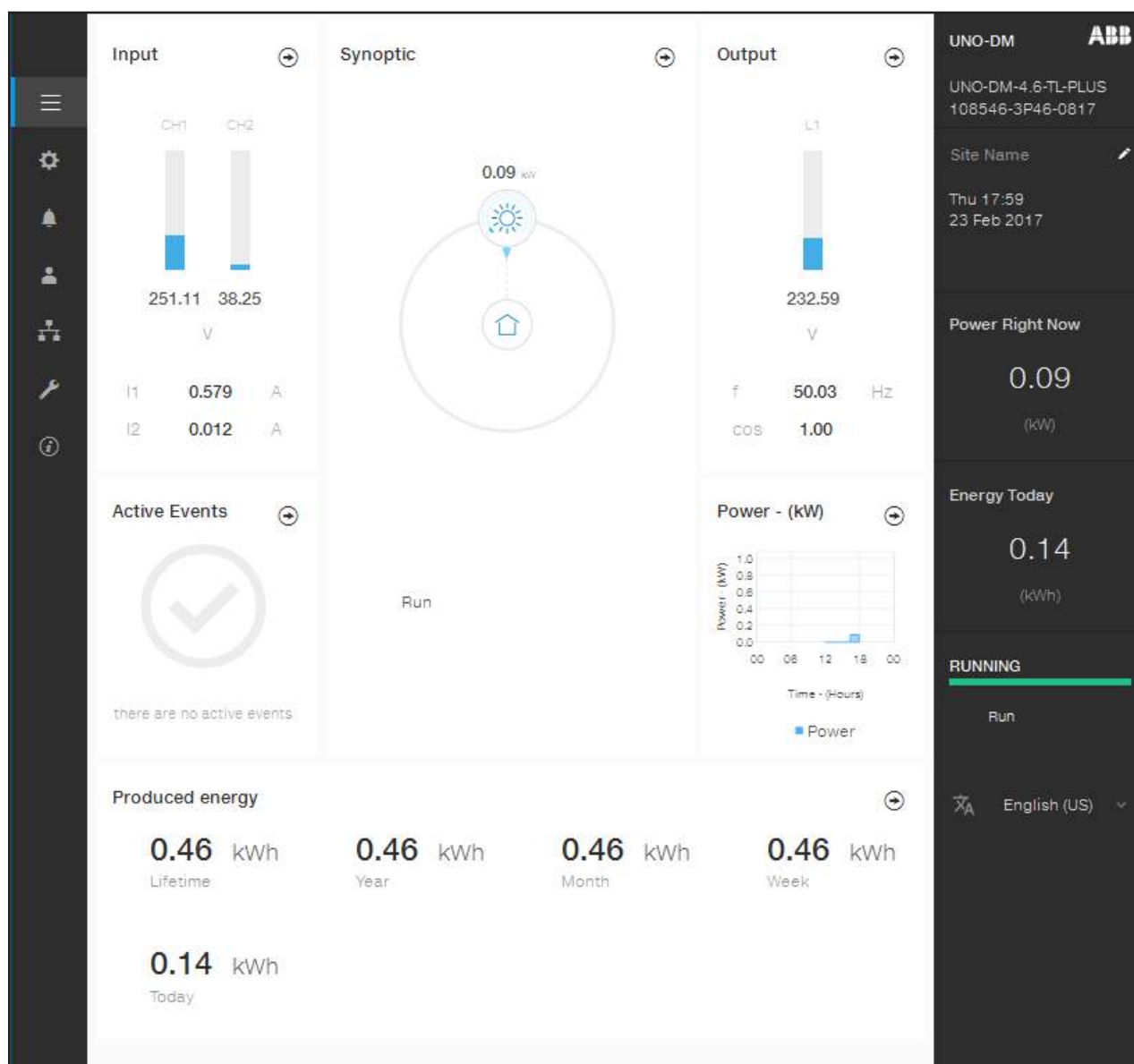

Status Summary

In the **Status Summary** sub-menu you can view the detailed informations related the status and the production informations of the system.

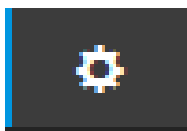

SETUP section

In the **SETUP** section it's possible to access the following sub-menus:

- **Setup DC Side**
- **Setup AC Side (Only visible and editable with Admin Plus privileges)**
- **Ground Fault Interface**

Setup DC Side

In the **Setup DC Side** sub-menu you can setup the parameter related to the Input DC side:

1. VStart1

This parameter is used to set the Vstart activation voltage for the input channel 1 if they are configured independently (If parallel you will see only a single "Vstart" parameter for both channels). This voltage imposes a minimum input voltage on the inverter above which connection to the grid will be attempted.

2. VStart2

This parameter is used to set the Vstart activation voltage for the input channel 2 if they are configured independently (If parallel you will see only a single "Vstart" parameter for both channels). This voltage imposes a minimum input voltage on the inverter above which connection to the grid will be attempted.

We advise changing the activation voltage only if really necessary and to set it to the correct value: the photovoltaic generator sizing tool available on the ABB website will indicate whether Vstart needs changing and what value to set it to.

3. Input Mode

This settings allows you to set the input configuration mode.

In particular:

- **Independent:** Independent configuration of the two input channels. This configuration is set by default.
- **Parallel:** Parallel configuration of the input channels (single input channel). Other hardware settings must be set on the inverter to set this mode. Refer to the paragraph "Parallel channel configuration".

4. UV Protection Time

This section of the menu allows you to set the time for which the inverter stays connected to the grid after the input voltage has dropped below the Under Voltage limit (set at 70% of Vstart).

This value can be set from 1 to 3600 seconds (60 seconds is the default setting).

5. Multiple Max Scan Enable

This settings allows you to Enables/disables the scan for identifying the maximum power point of the system.

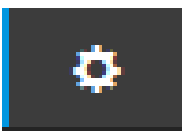

6. Multiple Max Scan Period

This settings allows you to set the time between scans. Remember that the shorter the scan interval the greater the loss of production, due to the fact that energy is transferred to the grid during the scan but not at the maximum power point. Each scan takes roughly 2 seconds..

7. MPPT Noise amplitude (Only visible and editable with Admin Plus privileges)

By changing this settings you can choose the amplitude of the DC perturbation introduced to establish the optimal operating point.

Setup AC Side (Only visible and editable with Admin Plus privileges)

In the **Setup AC Side** sub-menu you can setup the parameter related to the Output AC side:



Changing the above-mentioned parameters may prevent disconnection from the grid if the new values exceed those given in the standards of the country of installation. If these parameters are changed to values outside the standard range, an interface protection must be installed external to the inverter in accordance with the requirements of the country of installation.

1. Grid Protection

By editing these settings it's possible to enable/disable and change the grid protection intervention thresholds parameters.

2. Grid Connection

By editing these settings it's possible to change the grid connection thresholds parameters to which the inverter have to connect to the grid.

3. High Frequency Derating

By setting these parameters it's possible to change the output derating behavior of the inverter related to the grid frequency parameters.

4. Setup Average Vgrid Derating

By setting these parameters it's possible to change the output derating behavior of the inverter related to the average voltage parameters of the grid.



Ground Fault Interface

In the **Ground Fault Interface** sub-menu you can setup the parameter related to the Ground Fault Interface:

1. Minimum Riso (read only)

These read only field shown the measure of the insulation resistance of the PV generator comparedto ground.

2. Minimum time for Riso check

By editing this settings it's possible to change the necessary time for checking the Riso value.

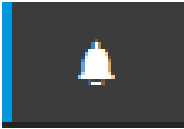

EVENTS Section

In the **EVENTS** Section it's possible to view the Alarm and Warning events list that it can be custom filtered by type or by entering a matching word.

Clicking on any event to view his details.

Alarm History

CLEAR FILTERS
REFRESH EVENTS

All Fault Warnings Info

1 of 1

Origin: inverter ⚠ W004 WARNING (CLOSED) AC GRID OVERVOLTAGE	23/02/2017 16:23:56
Origin: inverter ⚠ W007 WARNING (CLOSED) AC GRID UNDERFREQUENCY	22/02/2017 19:01:11
Origin: inverter ⚠ W022 WARNING (CLOSED) REACT POWER MODE CHANGED	22/02/2017 18:32:06
Origin: inverter ⚠ W006 WARNING (CLOSED) AC GRID OVERFREQUENCY	22/02/2017 17:10:06
Origin: inverter ⚠ W006 WARNING (CLOSED) AC GRID OVERFREQUENCY	22/02/2017 16:23:56

Event Details

Event Description

AC grid overvoltage - W004 - WARNING



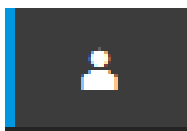

USER section

In the **USER** section it's possible to logout from webserver and return to the login page, or to access the following sub-menus:

- **Edit Email and Password**
- **Admin Plus**
- **User Management**

Edit Email and Password

In the **Edit Email and Password** sub-menu you can change the e-mail and password related to the user which is used to login to the web-server:

Admin Plus

By accessing to the **Admin Plus** sub-menu you can obtain the “Admin Plus” user privileges which allow you to:

- Change the grid standard of the inverter, after 24 hours while the inverter is operating (so the **Country Standard** sub-menu on **TOOLS** section is locked).
- View and edit the **Setup AC** sub-menu on **SETUP** section.
- View and edit the “**MPPT Noise amplitude**” field in **Setup DC** on **SETUP** section.

To access on the internal webserver with the “Admin Plus” user privileges it's required to enter a security token that it can be obtained by registering on the website <https://registration.abbsolarinverters.com>. Refer to the dedicated section on this topic in the manual.

User Management

By accessing to the **User Management** sub-menu it's possible to edit all the users already created and create new users (both with admin or User privileges).

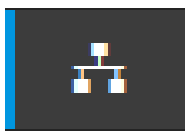

NETWORK section

In the **NETWORK** section it's possible to access the following sub-menus:

- **RS485**
- **WLAN Status**
- **Modbus TCP**
- **Debug Settings**

RS485

In the **RS485** sub-menu it's possible to adjust the settings relating to the RS485 communication serial line:

- RS485 Node Address: It allows you to set the address for serial communication of the individual inverters connected to the RS485 line. The UP and DOWN buttons scroll through the numerical scale. (The addresses that can be assigned are 2 to 63).
- RS485 Baud Rate: It allows you to set the Baud Rate (2400/4800/9600/19200/34800/57600/115200).
- RS485 Protocol Type: It allows you to set the type of protocol to be used for the RS485 line.
 - "Protocol Aurora Server": it's the proprietary ABB serial protocol usually used for back-compatibility or by service personnell.
 - "Modbus Sunspec Server": General purpose communication protocol to be selected to enable monitoring and control.
 - "Modbus Meter Interface": communication protocol to be selected for enable communication with the supported external meter.
 - RS485 Parity Mode: It allows you to set the Parity bit (No Parity, Even Parity, Odd Parity).





WLAN Status

In the **WLAN Status** sub-menu it's possible to view operation status and the information about the WLAN board for both of wireless channel and to switch between the two operation mode ("Station Mode" or "AP Mode").

WLAN Status

Wireless channel 1

You are connected through the channel 1 (Access Point)

Mode:	Access Point
Status:	on
SSID:	ABB-b0-72-bf-9f-e4-6a
IP:	192.168.117.1

Wireless channel 2

Mode:	Station
Status:	connected
Connected to:	Home_Network
Signal level:	Strong
IP:	10.21.43.201
Netmask:	255.255.252.0
DNS:	
Gateway:	it-r-valwificli

Edit channel 2 configuration

IP Settings

DHCP

Available Network (SSID)

Home_Network

Password

.....

Show password

Wireless channel 1 is always active and it's dedicated to operate in Access Point mode only.

Wireless channel 2 is dedicated to operate in "Station" mode. If the inverter is connected to channel 2 it will be shown all information regarding the wireless parameters.

You will be able to edit the configuration of wireless channel 2 only connecting to the channel 1.

If you are connected via channel 2, you can switch to Access Point mode and disconnect the inverter from the domestic wireless network by clicking "Switch to AP mode" button.

If the inverter wasn't previously connected to the router, it will now be possible to connect it by entering the following wireless network parameters (set on the router):

- IP Selection Mode: DHCP or Static:

If you select the DHCP function (default setup) the router will automatically assign a dynamic IP address to the inverter whenever it tries to connect to the user network.

With Static, the user can assign a fixed IP address to the system. The data which has to be entered in order for IP static address assigning to take place will appear. Complete the additional fields at the bottom of the screen (all the fields are mandatory with the exception of the secondary DNS server).

- Available Network (SSID):

Identify and select your own (home) wireless network from all those shown in the SSID field (you can carry out a new search of the networks that can be detected with the Update button ). Once the network has been selected, confirm.

- Password (wireless network password):

Enter the password for the destination network (if necessary) and start the connection attempt (it will take a few seconds).

Click on "Connect" button to switch the inverter wireless connection from point to point to the home wireless network.

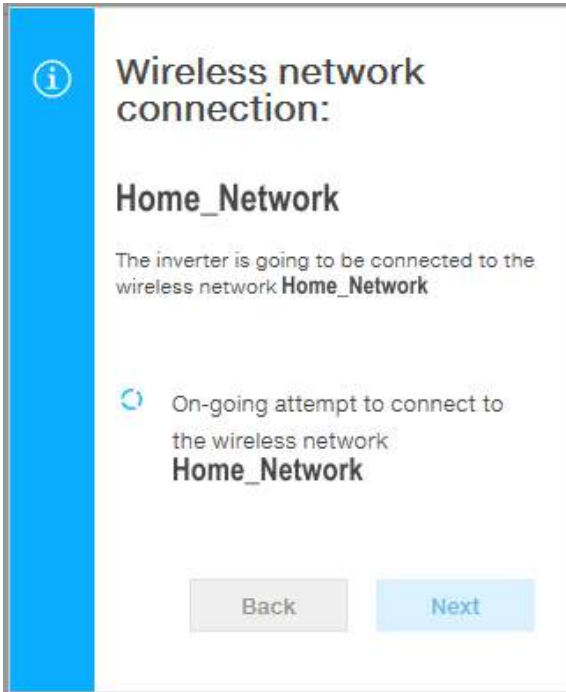
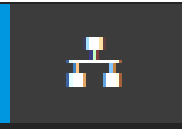

Once the inverter is connected to the domestic wireless network, a new message will confirm that the connection is acquired.

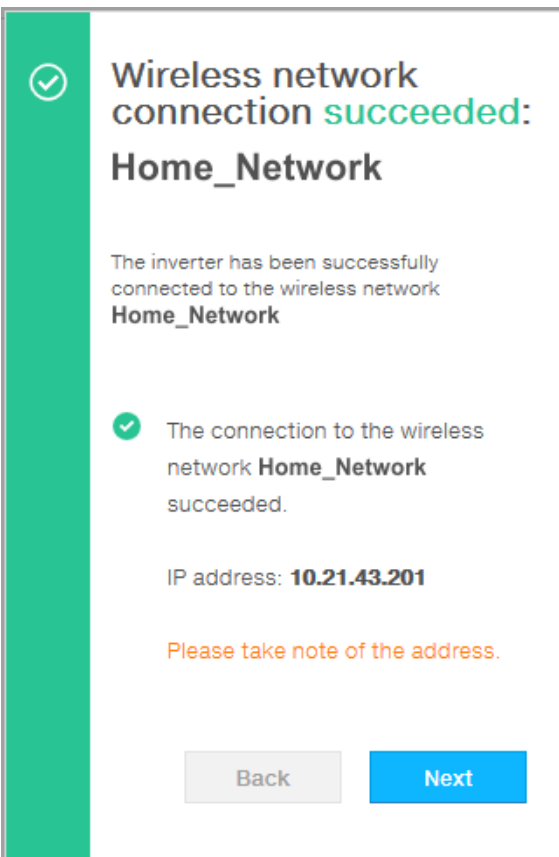

The message provides the IP Address assigned by the home wireless network router to the inverter that can be used each time you want to access the internal webserver, with the inverter connected to the home wireless network. **Take note of it.**

Click the “Next” button” to complete the setup of “Station Mode” connection.



The IP address assigned may vary for reasons connected to the wireless home router setup (for example, a very brief DHCP lease time). If verification of the address is required, it is usually possible to obtain the client list (and the corresponding IP addresses) from the wireless router administration panel.



The most common causes of losing connectivity might be: different wireless network password, faulty or unreachable router, replacement of router (different SSID) without the necessary setting updates.



Where possible, “Station Mode” is always preferable. Thanks to the internet connection, this mode ensures better operation.

Modbus TCP

In the **Modbus TCP** sub-menu it's possible to enable exchanging of data with third party monitoring and control systems over wireless channel in compliance with Sunspec register map, by setting “ON” the “Modbus TCP Server” parameter.



By changing “Modbus Power Control” parameter settings to “OFF” only reading register is enabled.

Debug Settings

In the **Debug Settings** sub-menu it's possible to enable or disable the Debugging access for ABB Service purposes.

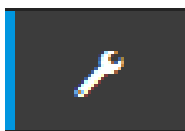

TOOLS section

In the **TOOLS** section it's possible to access the following sub-menus:

- **Dynamic Feed-in Control**
- **Local I/O Manager**
- **Country Standard**
- **Autotest CEI 0-21**
- **Firmware Update**
- **Date/Time**

Dynamic Feed-in Control

In the **Dynamic Feed-in Control** sub-menu it's possible to enable the management of power flows in order to optimize self-consumption or avoid feeding power to the grid (except during transitory), basing on the reading of the energy meter:



Installation of energy meter is required. Refer to the section "Connection of the energy meter" in the manual for the meter connection.

Dynamic Feed-In Control

Meter

Meter Model

Meter Phase

Energy Policy

Energy Policy

PV Generator Power (Wp)

Feed-In Power (% PV Generator Power)

SAVE

- **Meter:**

When a meter device is connected to the inverter, it's requested to select the meter model:

1. **None** (where system is installed without meter)
2. **REACT-MTR-1PH** (single-phase)
3. **ABB 1PH** (single-phase)
4. **ABB 3PH** (three-phase)



*If a 3PH energy meter (ABB B23, B24) is used in the system as single-phase inverter, it will be necessary to select **ABB 3PH** and the phase to which the inverter is connected.*

Once the meter model is selected, additional requested fields will appear:

- **METER PHASE:** If the METER is three-phase, the phase to which the inverter is connected must be selected. (This field will appear only if you select the ABB B23 3PH meter model)

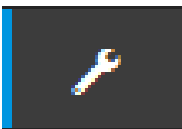

- **ENERGY POLICY:** set the way in which you want to manage the energy produced by the PV plant, choosing from the following:

Management mode	Description
Self consumption	The system automatically manages power flows in order to maximise self-consumption. All unused power from domestic loads will feed into the grid.
Zero injection	The system automatically manages power flows in order to avoid the injection of energy to the grid. If the meter is disconnected or not working the inverter's output power is restricted to zero in order to avoid accidental power feeding to the grid.
Configurable	The system automatically manages power flows in order to avoid feeding the grid with power greater than: $P_{DC} \times P_{lim}$ where P_{DC} is the power of the photovoltaic generator ("PV GENERATOR POWER" parameter) and P_{lim} is the output power limit with respect to $P_{DC}(\%)$ ("FEED-IN POWER" parameter).

- **PV GENERATOR POWER:** Insert the power value of the photovoltaic system (kWp) installed.
- **FEED-IN POWER:** Set the percentage AC power restriction (with reference to the value of the photovoltaic system (kWp) installed) to be feed into the grid. This field can be edited only if the Energy Policy selected is "Configurable".

Confirm the settings by clicking "END" and the inverter will test the meter working.

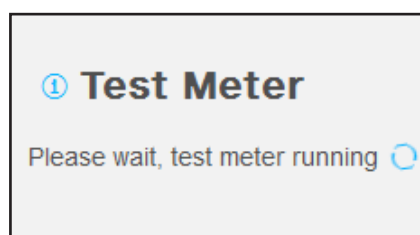

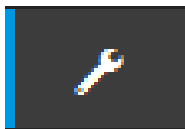

Local I/O Manager

In the **Local I/O Manager** sub-menu it's possible to enable the management of power flows in order to optimize self-consumption or avoid feeding power to the grid (this features will work only on inverter equipped with UNO-DM-COM KIT (-X models) or UNO-DM-PLUS-COM ETHERNET KIT (-E models)).

This section of the menu allows you to set the activation status of a relay (available either as contact normally open – N.O. - and as a normally closed contact -N.C.) and to configure customised alarm conditions.

This contact can be used, for example, to: activate a siren or a visual alarm, control the disconnect device of an external transformer, or control an external device. A little description of the alarm type (e.g. “alarm lamp”) is required.

Relay switching can be set in 9 different modes using the submenu **Set Alarm Type** (For the “Alarm Conf.”, “Al. Conf. Latch”, “Al. Conf. Ext.”, “GoGo Rel(Auto)” and “GoGo Rel(Slave)” it is possible to configure customised alarm conditions through the submenu **Alarm Config**:

- **Alarm Production - display text “Alarm-Contact (Production)”**

The relay is activated (status: switched) whenever the inverter connects to the grid; as soon as the inverter is disconnected from the grid (for whatever reason that caused disconnection), the relay is in its resting position.

- **Alarm with reset at the end of the alarm signalling process - display text “Alarm-Contact (alarm ALL - no-latch)”**

The relay is activated (status: switched) whenever an error (code Exxx) or warnings related to grid parameters out of range (Warning – codes W003, W004, W005, W006, W007) are present on the inverter. The alarm returns to its resting position when the alarm signal ends, i.e. before the inverter checks the grid parameters after the alarm state. This is because grid control state is not an alarm state but a state of normal operation.

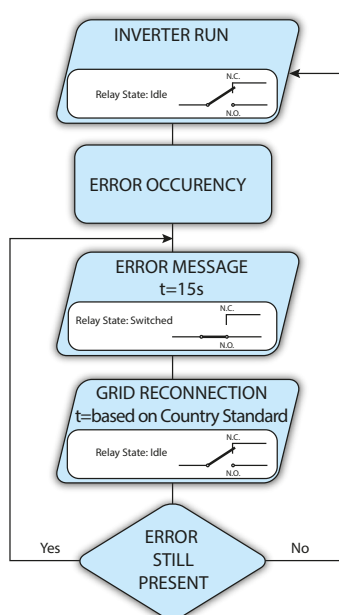
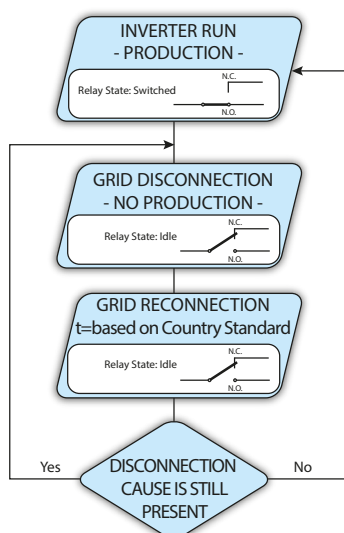

Alarms for which the relay is activated

E001	E002	E003	E004	E005	E006
E007	E010	E011	E012	E013	E014
E015	E016	E017	E018	E019	E020
E021	E022	E023	E025	E026	E027
E028	E029	E030	E031	E032	E033
E034	E035	E036	E037	E046	E050
E051	E053	E054	E055	E056	E057
E058	E065	E066	E067	E068	E069
E070	E074	E077	E078	E080	E084
E086	E087	E088	E089		
W002	W003	W004	W005	W006	W007
W009	W011	W015	W017	W018	W019
W021	W022	W023	W024	W027	W029
W030	W036	W037	W039	W040	W042
W043	W046	W047	W048	W051	W058
W059					



In the presence of W003, W004, W005, W006, W007 signalling, the alarm contact switches to then reset itself at the end of the alarm signal. This means that during the absence of grid voltage (display message “Missing Grid”) the alarm contact remains in its resting position.

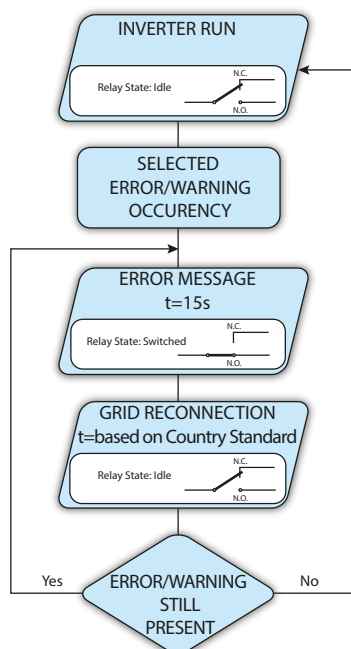
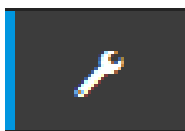

• **Configurable alarm with reset at the end of the alarm signalling process - display text “Alarm-Contact (alarm configurable - no-latch)”**

The relay is activated (status: switched) whenever an error (code Exxx) or a warning (code Wxxx) is present from those selected from the list in the dedicated submenu **Alarm Config** of the inverter display. The contact returns to its resting position when the alarm signal ends, i.e. before the inverter checks the grid after the alarm state. This is because grid control state is not an alarm state but a state of normal operation.

Alarms for which the relay is activated

E001	E002	E003	E004	E005	E006
E007	E010	E011	E012	E013	E014
E015	E016	E018	E019	E020	E021
E022	E023	E025	E026	E027	E028
E029	E030	E031	E032	E033	E034
E036	E037	E046	E050	E051	E053
E054	E055	E056	E057	E058	E065
E066	E067	E068	E069	E070	E074
E077	E078	E080	E084	E086	E087
E088	E089				
W002	W003	W004	W005	W006	W007
W009	W011	W015	W017	W018	W019
W021	W022	W023	W024	W025	W027
W029	W030	W031	W037	W039	W040
W042	W043	W046	W047	W048	W051
W058	W059				

For the configurable relay operating mode “Alarm Conf.”, the following considerations are valid:

If the alarm condition is persistent, the alarm contact cyclically switches from its resting state to its activated state.



In the presence of W002 signalling (Input UV – input voltage below the limit of operation), the alarm contact switches to then reset itself at the end of the alarm signal. This means that during the reduced input voltage (display message “Waiting Sun”) the alarm contact remains in its resting position.

In the presence of W003, W004, W005, W006, W007 signalling, the alarm contact switches to then reset itself at the end of the alarm signal. This means that during the absence of grid voltage (display message “Missing Grid”) the alarm contact remains in its resting position.

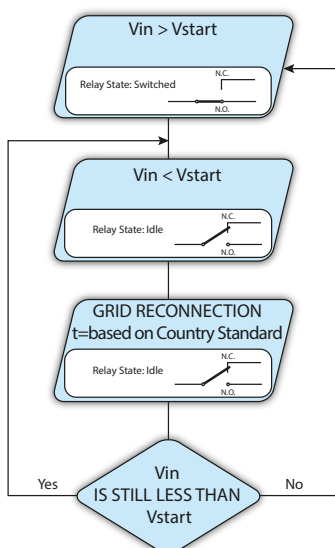
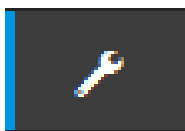

• **Crepuscular - display text “Alarm-Contact (crepuscular)”:**

The relay is activated (status: switched) as soon as the inverter input voltage exceeds the activation voltage set.

The relay switch to rest position when the input voltage drops below 70% of the activation voltage set.

This mode is useful for disconnecting any output transformers that could have unnecessary consumption during the night.

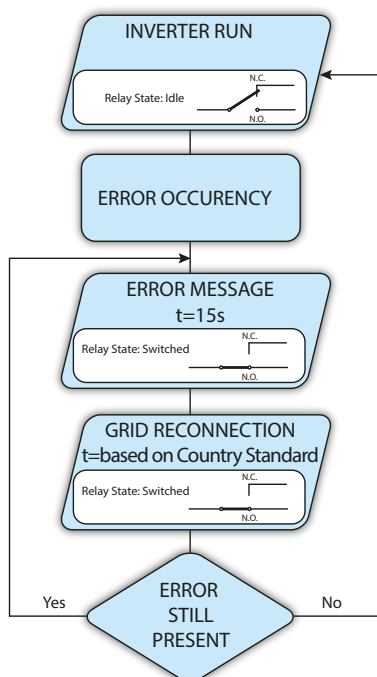

• **Alarm Latch - display text “Alarm-Contact (alarm ALL - latch)”:**

The relay is activated (status: switched) whenever an error (code Exxx) or a warning (code Wxxx) is present (see the table below). When the inverter returns to the normal operating state and reconnects with the grid, the contact returns to its position of rest.

Alarms for which the relay is activated

E001	E002	E003	E004	E005	E006
E007	E010	E011	E012	E013	E014
E015	E016	E017	E018	E019	E020
E021	E022	E023	E025	E026	E027
E028	E029	E030	E031	E032	E033
E034	E035	E036	E037	E046	E050
E051	E053	E054	E055	E056	E057
E058	E065	E066	E067	E068	E069
E070	E074	E077	E078	E080	E084
E086	E087	E088	E089		
W002	W003	W004	W005	W006	W007
W009	W011	W015	W017	W018	W019
W021	W022	W023	W024	W027	W029
W030	W036	W037	W039	W040	W042
W043	W046	W047	W048	W051	W058
W059					

If the alarm condition is persistent, the relay will remain activated (status:switched)

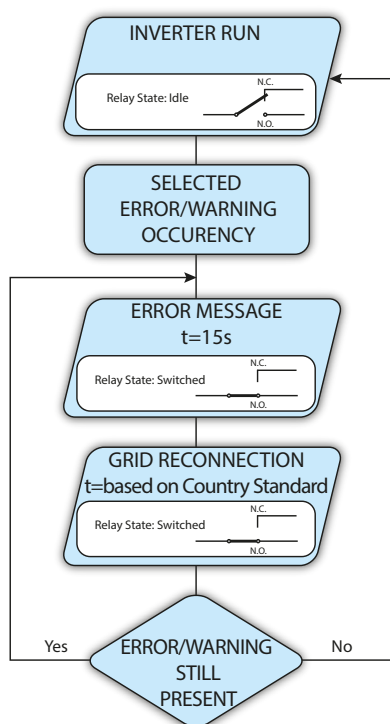
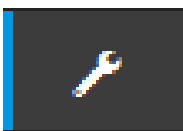

• **Latch configurable alarm - display text “Alarm-Contact (alarm configurable - latch)”:**

The relay is activated (status: switched) whenever an error (code Exxx) or a warning (code Wxxx) is present from those selected from the list in the dedicated submenu **Alarm Config** of the inverter display (see the table below). When the inverter returns to the normal operating state and reconnects with the grid.

Alarms for which the relay is activated

E001	E002	E003	E004	E005	E006
E007	E010	E011	E012	E013	E014
E015	E016	E018	E019	E020	E021
E022	E023	E025	E026	E027	E028
E029	E030	E031	E032	E033	E034
E036	E037	E046	E050	E051	E053
E054	E055	E056	E057	E058	E065
E066	E067	E068	E069	E070	E074
E077	E078	E080	E084	E086	E087
E088	E089				
W002	W003	W004	W005	W006	W007
W009	W011	W015	W017	W018	W019
W021	W022	W023	W024	W025	W027
W029	W030	W031	W037	W039	W040
W042	W043	W046	W047	W048	W051
W058	W059				

If the alarm condition is persistent, the relay will remain activated (status:switched)



• **Ext configurable alarm - display text “Alarm-Contact (alarm configurable - matrix)”:**

In this mode, it is possible to configure the behaviour of the alarm relay according to an external error table which can be setup with the Aurora Manager LITE software. In the table it is possible to select the alarms or warnings for which the alarm relay is activated (status: switched); for each individual alarm it is also possible to select the “Latch” or “No Latch” mode.

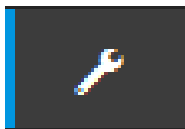

• Load Manager - display text “Load Management”:

Load Manager functionality it allow you to define configurable power thresholds for which the relay is activated (status: switched) to a specific configurable power thresholds.

Once this mode has been selected, the parameters for which the relay is activated and deactivated have to be set.

If the energy meter is installed in the plant the power thresholds “Power Threshold On” and “Power Threshold Off” refers to the Power injected into the Grid (Pgrid); if the energy meter is not installed refers to Inverter output Power (Pout).

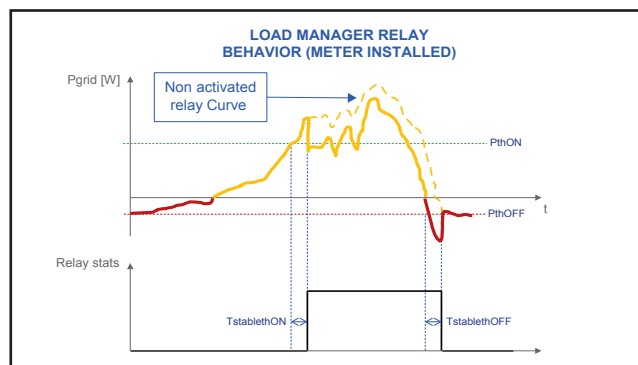
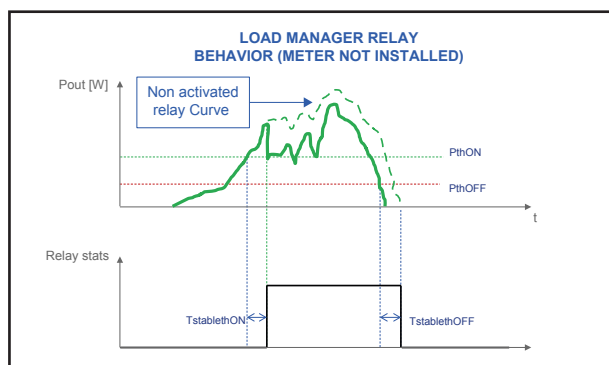

Local I/O Manager Settings

Config

Description ⓘ

Required

Mode

Power Threshold On [W]

Power Threshold Off [W]

TStableThOnM (Minutes)

TStableThOffM (Minutes)

- Mode: It's possible to select AUTO (which is the default values for a load management working), ON (which lock the relay in switched status), OFF (which lock the relay in rest status).

- Power Threshold On [W]: Upper Power threshold (Pgrid/ Pout) for which the relay is activated (status: switched).

- Power Threshold Off [W]: Lower Power threshold (Pgrid/ Pout) for which the relay is deactivated (status: rest position).

- TStableThOnM (Minutes): Minimum time for which the Pgrid/Pout shall remain above the “Power Threshold On” relay activation (status: switched).

- TStableThOffM (Minutes): Minimum time for which the Pgrid/Pout shall remain under the “Power Threshold Off” before the relay deactivation (status: rest position).

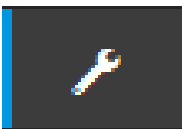

Country Standard

By accessing to the **Country Standard** sub-menu you can modify the grid standard within 24 hours while the inverter is operating.



*After the grid standard was set you have 24 hours to make any changes to the grid standard value; 24 hours later the **Country Standard** sub-menu will be locked, and any subsequent changes can only be made accessing with **Adim Plus** privileges. Refer to the dedicated section on this topic in the manual to know how to unlock the **Country Standard** sub-menu.*

Country standard

① You can change the parameter in the first 24 hours if you logged in as admin. After this time, you can reset the 24 hours only if you logged in as admin plus

Grid Standard

CEI 021 - internal protection ▼

RESET SAVE



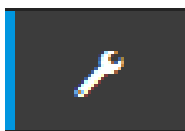

Autotest CEI 0-21

By accessing to the **Autotest CEI 0-21** sub-menu you can launch an autotest procedures according to the grid standard CEI-021.

AUTOTEST CEI 0-21

ⓘ Last execution: ---
 Result: ---
[Download the report](#)

Test Selection

U>> Max Tensione ---

U> Max Tensione ---

U> (10 min) Max Tensione media ---

U< Min Tensione ---

U<< Min Tensione ---

F>> Max Frequenza ---

F> Max Frequenza ---

F< Min Frequenza ---

F<< Min Frequenza ---

START

The conditions required to perform an Autotest are:

- The grid standard must be set to CEI-021.
- You must not intervene in any way while the test is underway
- You must check that the equipment has a stable grid connection.

Select the type of test required from the list and click on “START” button. A notification confirm request will appear.

While one of the tests is being performed, the set limits will be gradually increased/reduced (depending on the type of test) until the threshold at which the inverter is disconnected from the grid is reached. The procedures for running the Autotest comply with the legislation in force.

At the end of the tests a message will confirm the results and it will be possible to download a .pdf file report of the test that has been done.

AUTOTEST CEI 0-21

ⓘ Last execution: 23/02/2017 at 4:23PM
 Result: Success
[Download the report](#)

Test Selection

U>> Max Tensione ✔

U> Max Tensione ---

U> (10 min) Max Tensione media ---

U< Min Tensione ---

U<< Min Tensione ---

F>> Max Frequenza ---

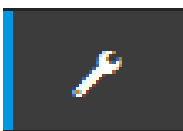

Firmware Update

By accessing to the **Firmware Update** sub-menu you can upgrade the firmware of the inverter and his components selecting a Remote firmware Update or a Local firmware Update.



*Perform the update during good irradiation conditions (avoid the dawn and dusk hours).
An interruption of updating process could damage the inverter!*

←

Remote FW Update

You can update the inverter connecting to Aurora Vision. The procedure may take several minutes.

Remote
Local

Inverter

Current Firmware Release
----- - 0.8.2

Available Release
none - 0.8.3

UPDATE

• Remote firmware Update:

- In remote mode, the firmware will update automatically, searching the last available firmware on ABB servers, by clicking the “CHECK” button.

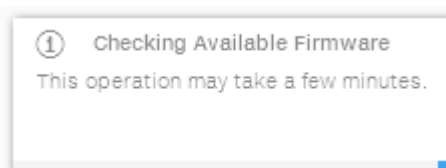

- After the finish of the checking process the available release will be notified on the bottom part of the section
- Click on “UPDATE” button to start with the updating process.

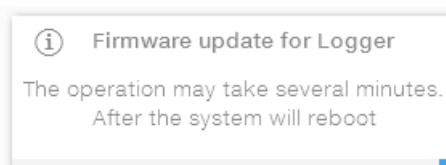

• Local firmware Update:

By updating in local mode, the firmware have to be selected and uploaded from local folder of the used devices to access to the web server. The latest firmware version is available from the download area of the website www.abb.com/solarinverters or from <https://registration.abbsolarinverters.com>

- Click on “FW SELECT” and select the firmware package previously downloaded.

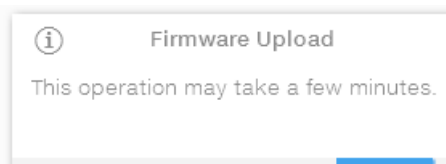

- Click on “UPDATE” button to start with the updating process.

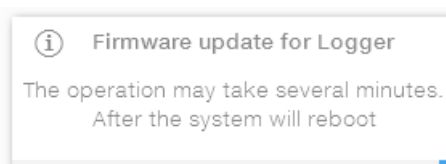



Date and Time

In the **Date and Time** sub-menu it's possible to set the date, time and time zone.

The inverter will propose these fields when the time protocol is available).

When it's not possible for the inverter to detect the time protocol, these fields have to be manually entered.

Date and Time

✔ Network Time Protocol server has been detected and it will be used to keep the system clock synchronized.

Date ✔

Feb 22, 2017

SET by the NTP server

Time ✔

4:52 PM

SET by the NTP server

Time Zone

Europe/Berlin GMT+01:00 ▼

SAVE



INFORMATION Section

In the **INFORMATION** Section it's possible to view the general informations about the embedded webserver.

it's possible to access the following sub-menus:

- **Privacy Policy**
- **Provider Information/Impressum**
- **Acknowledgments**
- **Release Notes**





Description of the Display menus

The ABB inverters are equipped with a graphic display ①7, consisting of 2 lines of 16 characters each, which can be used to:

- Display the operating status of the inverter and the statistical data
- Display service messages for the operator
- Display the alarm and fault messages
- Change the inverter settings.

General information

While the inverter is operating, the display shows various items of information on the main parameters measured, the operating conditions and the inverter's operating status.

When the icon  appears on the display, information is shown cyclically; if the padlock icon  is displayed it means that the display of information is locked and the UP and DOWN buttons can be used to scroll through the screens of information instead.

The sequence of screens displayed is shown below, with a description of the parameters monitored.

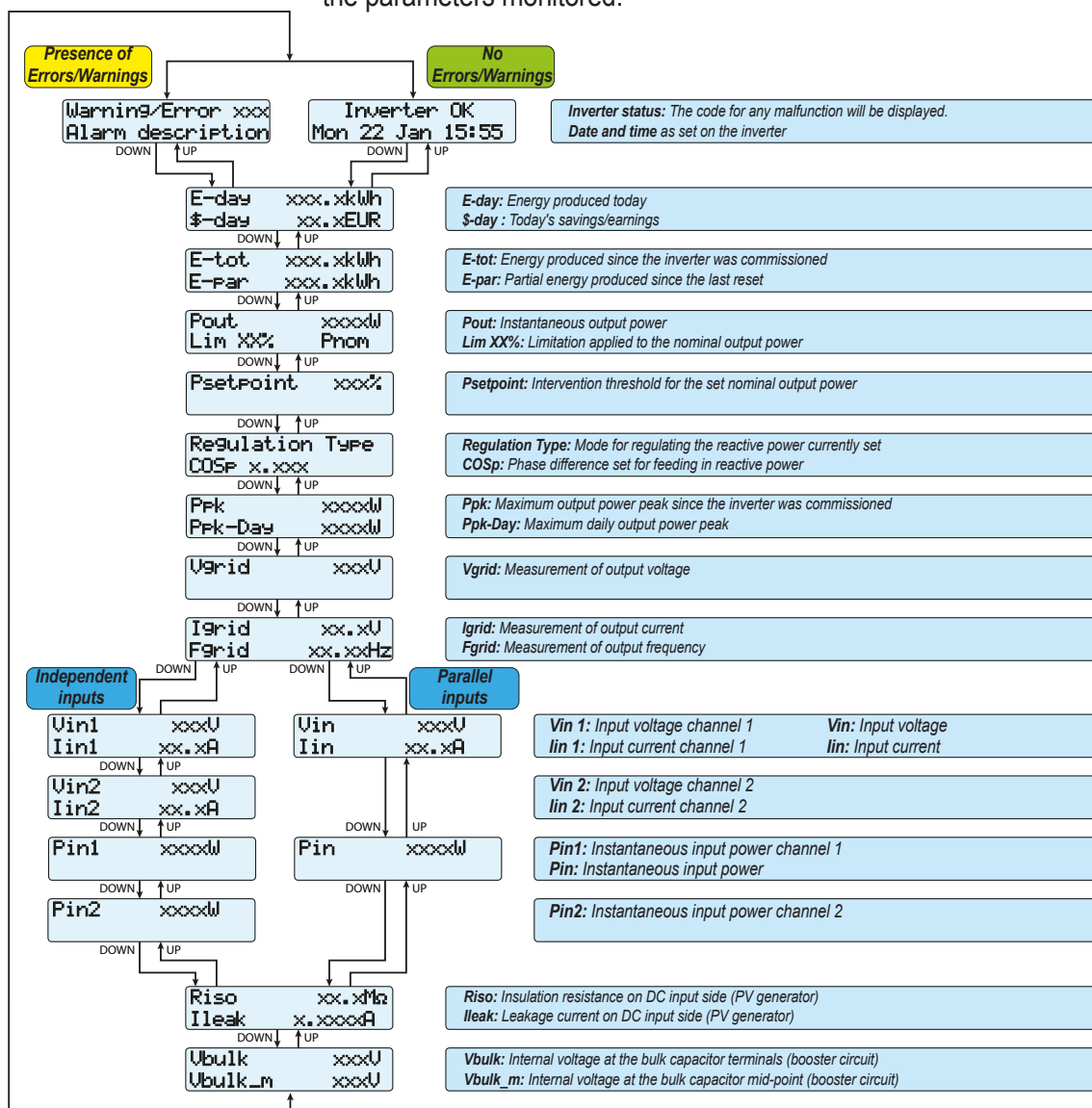

Menu structure

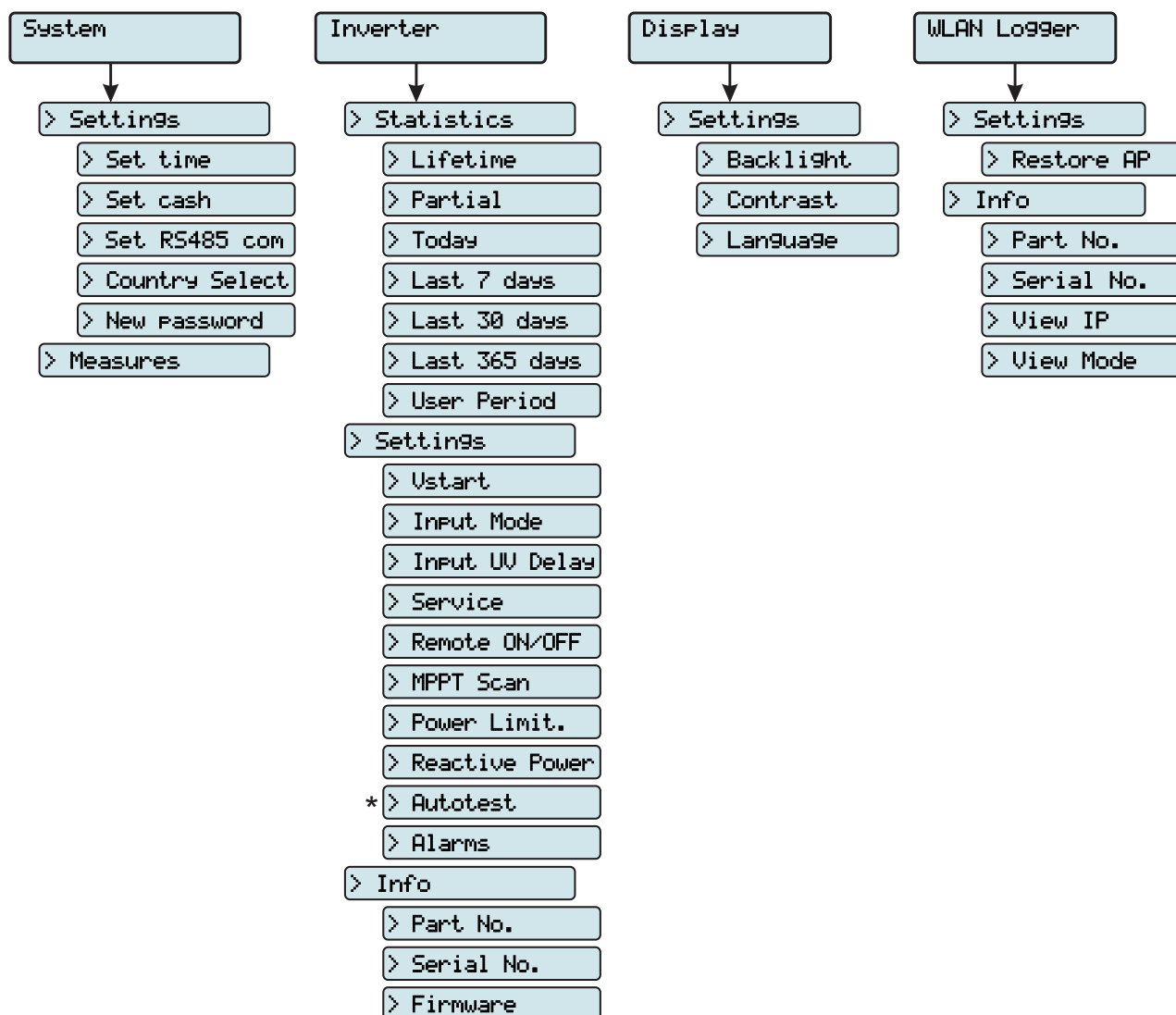

(*): Available for the Italian country standard only.

System Menu

By selecting the **System** menu, the following menus can be accessed:

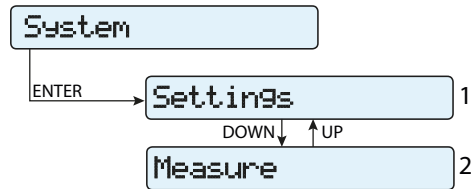

Settings

Selecting **Settings** brings up the first screen relating to the password.

The default password is "0000".

This can be modified by using the display buttons, always following the same procedure:

- ENTER scrolls through the digits (from left to right)
- ESC returns to the previous digit (from right to left)
- Press ESC several times to return to the previous menus
- DOWN scrolls down the numerical scale (from 9 to 0)
- UP scrolls up the numerical scale (from 0 to 9)

After entering the password, press ENTER to access the information in this section:

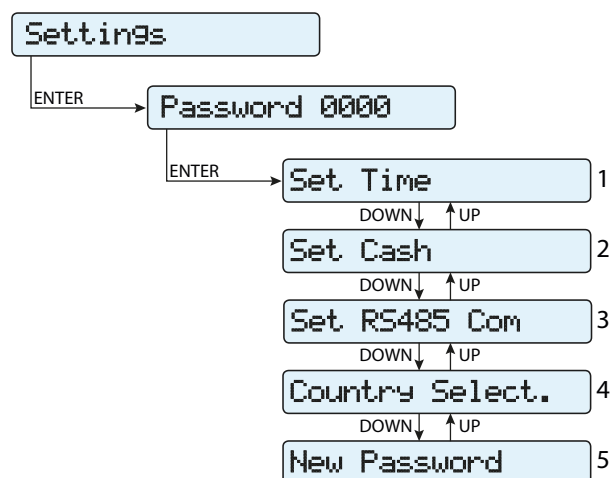

1. Set Time

Allows you to set the current date and time (not counting summer time)

2. Set Cash

This section of the menu allows you to set the name of the currency and the value of 1 kWh of energy produced. Setting these parameters correctly allows the actual earnings/savings achieved by the system to be displayed.

- **Currency:** sets the desired currency (default is Euro)
- **Val/KWh:** indicates the cost/incentive for 1 kWh in the chosen currency (default is 0.50).

3. Set RS485 Com

This section of the menu allows you to adjust the settings relating to the RS485 communication serial line:

Set Port 1:

- **Address RS485:** It allows you to set the address for serial communication of the individual inverters connected to the RS485 line. The UP and DOWN buttons scroll through the numerical scale. (The addresses that can be assigned are 2 to 63).
- **Protocol:** It allows you to set the type of protocol to be used for the RS485 line. The proprietary "Aurora-(Slave)", "ModBusRTU-ABB", "ModBusRTU-Sunsp" or "ModBusRTU-Meter" protocol can be selected depending on the device to which the inverter communicates.
- **Parity:** It allows you to set the Parity bit (None, Even, Odd).
- **Baud Rate:** It allows you to set the Baud Rate (2400/4800/9600/19200/34800/57600/115200).

4. Country Select.

It allows you to modify the grid standard (this option can be selected before the inverter is switched on) within 24 hours while the inverter is operating.

- **Set Std:** allows you to set the required grid standard.
- **Residual Time:** indicates the time remaining until the "Country Select" feature is blocked.
- **Reset Country:** Unlocks the grid standard selection (resets the 24 hours available for changing the grid standard).



After the grid standard was set you have 24 hours to make any changes to the grid standard value; 24 hours later the "Country Select." functionality will be blocked, and any subsequent changes can only be made using a password provided on request by ABB (refer to dedicated chapter in this manual).

5. New Password

This section of the menu allows you to change the settings menu password (default 0000).



We advise you to memorise the new password. If the Password is lost you will not have access to the inverter, since there is no Reset function for security reasons.

Measures

By selecting **Measures** it is possible to display the instantaneous value of the input power (PV Pw) and the instantaneous value of the output power (Pinv).

Inverter Menu

By selecting the **Inverter** menu, the following submenus can be accessed:

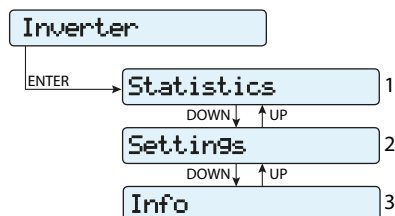

Statistics

By selecting **Statistics**, the following menus can be accessed:

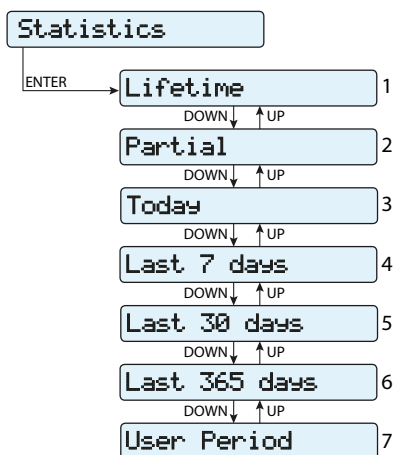

1. Total

This section of the menu displays the Total statistics:

- **Time:** Total operating time
- **E-tot:** Total energy produced
- **P-Peak:** Peak power value
- **Val. :** Total production value, calculated using the currency and conversion coefficient set in the relevant section of the SETTINGS menu
- **CO₂:** Amount of CO₂ saved compared to fossil fuels

2. Partial

This section of the menu displays the Partial statistics:

- **Time:** Partial operating time
- **E-par:** Partial energy produced
- **Val. :** Partial production value, calculated using the currency and conversion coefficient set in the relevant section of the SETTINGS menu
- **CO₂:** Partial amount of CO₂ saved



To reset all the counters of this sub-menu, press the ENTER button for more than 3 seconds. At the end of this time, you will hear a sound repeated 3 times.

3. Today

This section of the menu displays today's statistics:

- **E-day:** Energy produced today
- **P-Peak:** Today's peak power value
- **Val. :** Value of today's production, calculated using the currency and conversion coefficient set in the relevant section of the SETTINGS menu
- **CO₂:** Amount of CO₂ saved today

4. Last 7 days

This section of the menu displays the statistics for the last 7 days:

- **E-7d:** Energy produced over the last 7 days
- **Val. :** Value of production over the last 7 days, calculated using the currency and conversion coefficient set in the relevant section of the SETTINGS menu
- **CO₂:** Amount of CO₂ saved over the last 7 days

5. Last 30 days

This section of the menu displays the statistics for the last 30 days:

- **E-30d:** Energy produced over the last 30 days
- **Val. :** Value of production over the last 30 days, calculated using the currency and conversion coefficient set in the relevant section of the SETTINGS menu
- **CO₂:** Amount of CO₂ saved over the last 30 days

6. Last 365 days

This section of the menu displays the statistics for the last 365 days:

- **E-365d:** Energy produced over the last 365 days
- **Val. :** Value of production over the last 365 days, calculated using the currency and conversion coefficient set in the relevant section of the SETTINGS menu
- **CO₂:** Amount of CO₂ saved over the last 365 days

7. User period

This section of the menu displays the statistics for a period chosen by the user.

Once the start and end dates for the period have been set, the following data are available:

- **E-user:** Energy produced over the selected period
- **Val. :** Value of production over the selected period, calculated using the currency and conversion coefficient set in the relevant section of the SETTINGS menu
- **CO₂:** Amount of CO₂ saved over the selected period



Settings

Selecting **Settings** brings up the first screen relating to the password.

The default password is "0000".

This can be changed by using the display buttons, following the same procedure as always:

- ENTER scrolls through the digits (from left to right)
- ESC returns to the previous digit (from right to left)
- Press ESC several times to return to the previous menus
- DOWN scrolls down the numerical scale (from 9 to 0)
- UP scrolls up the numerical scale (from 0 to 9)

After entering the password, press ENTER to access the information in this section:

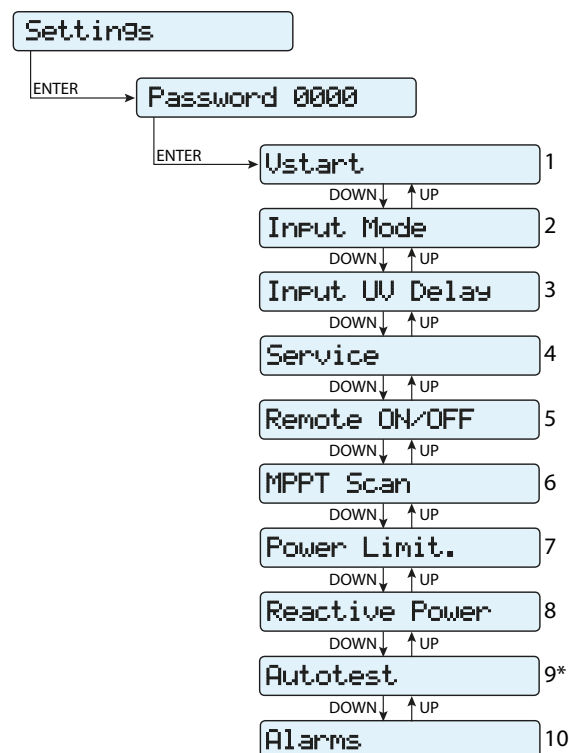

(*) Available for the Italian country standard only. Refer to the section on this topic in the manual.

1. Vstart

This section of the menu is used to set the Vstart activation voltage (for the two channels separately if they are configured independently) to adapt it to the needs of the system. This voltage imposes a minimum input voltage on the inverter above which connection to the grid will be attempted.



We advise changing the activation voltage only if really necessary and to set it to the correct value: the photovoltaic generator sizing tool available on the ABB website will indicate whether Vstart needs changing and what value to set it to.

2. Input Mode

This section of the menu allows you to set the input configuration mode. In particular:

- **Independent:** Independent configuration of the two input channels. This configuration is set by default.
- **Parallel:** Parallel configuration of the input channels (single input channel). Other hardware settings must be set on the inverter to set this mode. Refer to the paragraph “Parallel channel configuration”.

3. Input UV Delay

This section of the menu allows you to set the time for which the inverter stays connected to the grid after the input voltage has dropped below the Under Voltage limit (set at 70% of Vstart).

This value can be set from 1 to 3600 seconds (60 seconds is the default setting).



Example: With Input UV Delay set at 60 seconds, if voltage V_{in} drops below 70% of Vstart at 9.00, the inverter stays connected to the grid (taking power from it) until 9.01.

4. Service

This section of the menu is reserved for installers.

A special access password is required, which may be obtained from the website <https://registration.ABBSolarInverters.com>.

Before connecting to the site, make sure you have all the information required to calculate your password: Inverter Model, Serial Number and week of manufacture of the Inverter

When you have a password you can set the parameters in the menu.

Changing the above-mentioned parameters may prevent disconnection from the grid if the new values exceed those given in the standards of the country of installation. If these parameters are changed to values outside the standard range, an interface protection must be installed external to the inverter in accordance with the requirements of the country of installation.

The table below shows the parameters which cannot be modified.

Parameter	Description
Set U>>	Grid over-voltage (OV) threshold (extended range)
Set U>	Grid over-voltage (OV) threshold (restricted range)
Set U> (10Min)	Grid over-voltage (OV) threshold (average grid voltage value)
Set U<	Grid under-voltage (UV) threshold (restricted range)
Set U<<	Grid under-voltage (UV) threshold (extended range)
Set F>>	Grid over-frequency (OF) threshold (extended range)
Set F>	Grid over-frequency (OF) threshold (restricted range)
Set F<	Grid under-frequency (UF) threshold (restricted range)
Set F<<	Grid under-frequency (UF) threshold (extended range)
Set Connect	
> Set U>Connect	Max. permissible voltage during checks prior to grid connection
> Set U<Connect	Min. permissible voltage during checks prior to grid connection
> Set F>Connect	Max. permissible frequency during checks prior to grid connection
> Set F<Connect	Min. permissible frequency during checks prior to grid connection
> Set Time con.	Grid check time prior to connection
> Set T GridFault	Grid check time prior to connection after a grid fault
Set Slow Ramp	Enables gradual ramping up of power after the grid connection.
Set OF Derating	
> OF Der. Mode	Selects the power derating mode in the event of grid over-frequency.
> OF Der. Res. T.	Time period after OF derating in which the inverter checks that the frequency is back within the operating ranges (parameters "F<Connect" "F>Connect") required by the grid standard before ramping up the output from the derating condition.
Reset Latch	Allows the Latch alarms present to be reset manually



5. Remote ON/OFF

This section of the menu is used to enable/disable connection/disconnection of the inverter from the grid using the special control signal (**R+**) for inverter equipped with UNO-DM-COM KIT (-X models) or UNO-DM-PLUS-COM ETHERNET KIT (-E models).

- **Disabled:** the connection/disconnection of the inverter to/from the grid is dictated by the input (voltage from the photovoltaic generator) and output (grid voltage) parameters of the inverter.
- **Enable:** connection/disconnection of the inverter from the grid is dictated (as well as by the inverter input - voltage from the photovoltaic generator - and output parameters - grid voltage) by the state of the signal **R+** with respect to the signal **RTN**.

6. MPPT Scan

This section of the menu allows you to set the parameters of the maximum power point tracking (MPPT) function. This function is useful when there are areas of shade on the PV generator, which may create several points of maximum power on the operating curve.

- **E/D MPPT Scan:** Enables/disables the scan for identifying the maximum power point of the system.
- **Scan Interval:** This section allows you to set the time between scans. Remember that the shorter the scan interval the greater the loss of production, due to the fact that energy is transferred to the grid during the scan but not at the maximum power point. Each scan takes roughly 2 seconds.

7. Power Limit.

This section of the menu allows you to adjust the limit to the active power that the inverter can feed into the grid by setting the percentage of nominal power at which the limit should be triggered.

Setting it to 100% resets the default maximum power, which in some installation country standards may be 110% of nominal power



8. Reactive Power

This section of the menu may be used to manage the supply of reactive power into the grid. There are 5 possible types of management:

- **Q: No Regulation:** no regulation of reactive power. To activate this mode, press **ENTER** and then press **ENTER** to confirm.
- **Cos-phi fixed:** Sets the power rating to a fixed value. To activate this mode, press **ENTER** and set the Cos-Phi value to Over excited or Under excited, from 1.000 to 0.8000; press **ENTER** to confirm.
- **Q Fixed:** Sets the reactive power to a fixed value. To enable this mode, select **Enable** and then **OK** (using the UP / DOWN arrows). When enabled, **Set value** will appear on the display, allowing you to set the value of the reactive power (as either Over or Under excited, from 1.000 to 0.001)
- **Cos-phi = f(P):** Power rating as a function of the active power supplied by the inverter. To enable this mode, select **Enable** and then **OK** (using the UP / DOWN arrows). When it has been enabled, **Load std curve** will appear on the display, allowing you to set the following control curve:

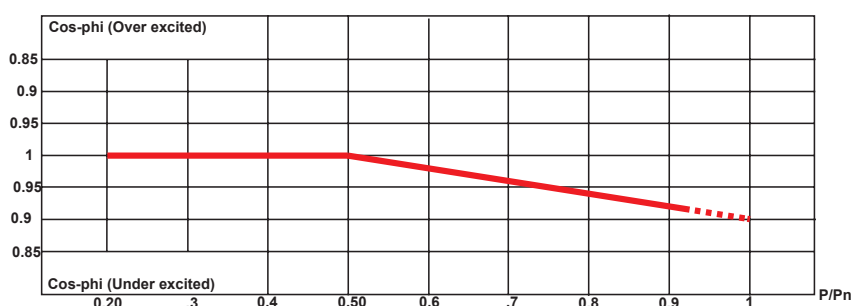

The curve can be modified using the Aurora Manager Lite configuration software

- **Q = f(U):** reactive power as a function of the grid voltage measured by the inverter. To enable this mode, select **Enable** and then **OK** (using the UP / DOWN arrows). When it has been enabled, **Load std curve** will appear on the display, allowing you to set the following control curve:

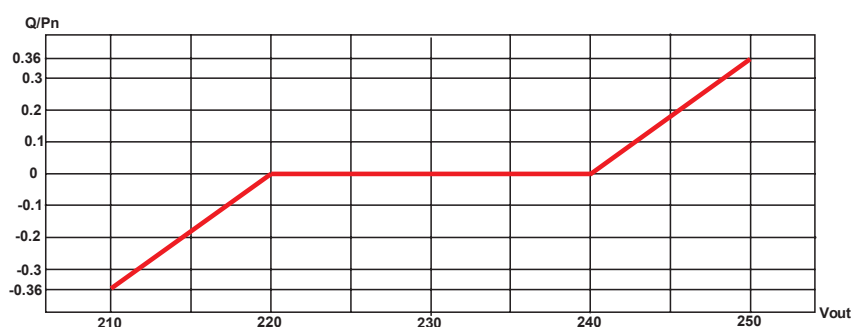

The curve can be modified using the Aurora Manager Lite configuration software

9. Autotest

This section of the menu is available only for the Italian country standard.

The autotest according to the grid standard CEI-021 can be launched via the menu on the display.

The conditions required to perform an Autotest are:

- The grid standard must be set to CEI-021.
- You must not intervene in any way while the test is underway
- You must check that the equipment has a stable grid connection.

In the Autotest section of the SETTINGS menu, select the type of test the equipment is to run from the following:

OV Test – parameters:

U>>; U>; U> (10Min)

Disconnection from the distribution grid due to “Over-voltage”

UV Test – parameters:

U<<; U<

Disconnection from the distribution grid due to “Under-voltage”

OF Test – parameters:

F>> and F>

Disconnection from the distribution grid due to “Over-frequency”

UF Test – parameters:

F<< and F<

Disconnection from the distribution grid due to “Under-frequency”

Go to the SETTINGS > Autotest menu

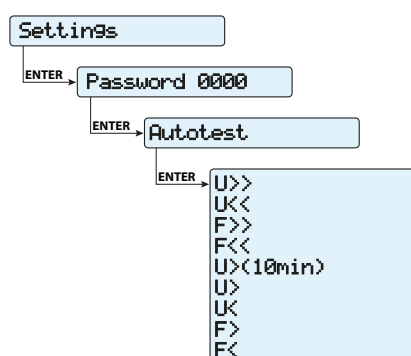

If one of the protections is disabled (from the Service menu), N/A (not applicable) will appear next to the name of the test.

While one of the tests is being performed, the set limits will be gradually increased/reduced (depending on the type of test) until the threshold at which the inverter is disconnected from the grid is reached. The procedures for running the Autotest comply with the legislation in force.

The display shows the message “Performing Test” when the test has started.

```
Test in corso
*****
```

At the end of the test, when the inverter has disconnected from the grid, the results and values of the test performed will appear on the display. You can move from one screen to another using the UP/DOWN arrow keys.

Details of the data available in each screen are provided below:

Screen 1 of 3

```
123456 XXX 1/3
Test: OK
```

Inverter serial number
 Parameter tested (e.g. U>>)
 Screen number
 Test result

Screen 2 of 3

```
123456 XXX 2/3
YYY Y ZZZZ
```

Inverter serial number
 Parameter tested (e.g. U>>)
 Screen number
 Value of the grid parameter detected when the safeguard was tripped
 Measured protection tripping time

Screen 3 of 3

```
123456 XXX 3/3
YYY Y ZZZZ
```

Inverter serial number
 Parameter tested (e.g. U>>)
 Screen number
 Protection tripping value
 Set protection tripping time

The test results should be considered valid on the basis of the following tolerances, as reported in the applicable legislation:

- $\leq 5\%$ for voltage thresholds
- ± 20 mHz for frequency thresholds
- $\leq 3\% \pm 20$ ms for tripping times

Press ESC to go back to the Autotest menu, from where you may select the next test to be performed

10. Alarm

This features will work only on inverter equipped with UNO-DM-COM KIT (-X models) or UNO-DM-PLUS-COM ETHERNET KIT (-E models).

This section of the menu allows you to set the activation status of a relay (available either as contact normally open – N.O. - and as a normally closed contact -N.C.) and to configure customised alarm conditions.

This contact can be used, for example, to: activate a siren or a visual alarm, control the disconnect device of an external transformer, or control an external device.

Relay switching can be set in 9 different modes using the submenu **Set Alarm Type** (For the "Alarm Conf.", "Al. Conf. Latch", "Al. Conf. Ext.", "GoGo Rel(Auto)" and "GoGo Rel(Remote)" it is possible to configure customised alarm conditions through the submenu **Alarm Config**:

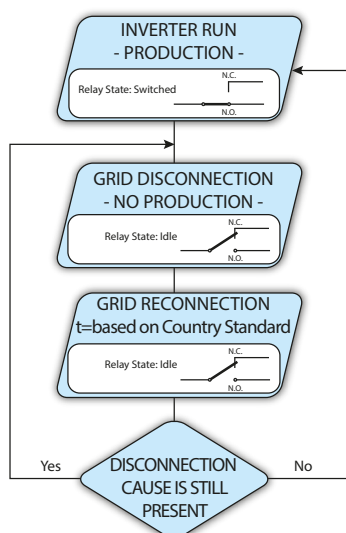

• Production (display text "Production")

The relay is activated (status: switched) whenever the inverter connects to the grid; as soon as the inverter is disconnected from the grid (for whatever reason that caused disconnection), the relay is in its resting position.

• Alarm with reset at the end of the alarm signalling process (display text "Alarm"):

The relay is activated (status: switched) whenever an error (code Exxx) or warnings related to grid parameters out of range (Warning – codes W003, W004, W005, W006, W007) are present on the inverter. The alarm returns to its resting position when the alarm signal ends, i.e. before the inverter checks the grid parameters after the alarm state. This is because grid control state is not an alarm state but a state of normal operation.

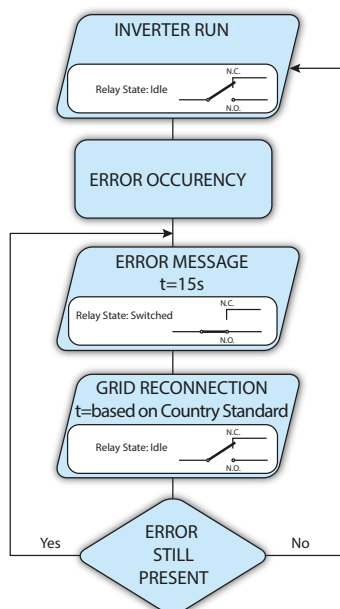

Alarms for which the relay is activated

E001	E002	E003	E004	E005	E006
E007	E010	E011	E012	E013	E014
E015	E016	E017	E018	E019	E020
E021	E022	E023	E025	E026	E027
E028	E029	E030	E031	E032	E033
E034	E035	E036	E037	E046	E050
E051	E053	E054	E055	E056	E057
E058	E065	E066	E067	E068	E069
E070	E074	E077	E078	E080	E084
E086	E087	E088	E089		
W002	W003	W004	W005	W006	W007
W009	W011	W015	W017	W018	W019
W021	W022	W023	W024	W027	W029
W030	W036	W037	W039	W040	W042
W043	W046	W047	W048	W051	W058
W059					

In the presence of W003, W004, W005, W006, W007 signalling, the alarm contact switches to then reset itself at the end of the alarm signal. This means that during the absence of grid voltage (display message "Missing Grid") the alarm contact remains in its resting position.

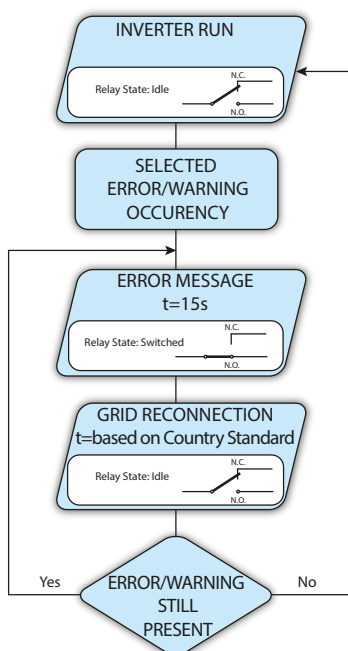

• **Configurable alarm with reset at the end of the alarm signalling process (display text “Alarm Conf.”)**

The relay is activated (status: switched) whenever an error (code Exxx) or a warning (code Wxxx) is present from those selected from the list in the dedicated submenu **Alarm Config**. The contact returns to its resting position when the alarm signal ends, i.e. before the inverter checks the grid after the alarm state. This is because grid control state is not an alarm state but a state of normal operation.

Alarms for which the relay is activated

E001	E002	E003	E004	E005	E006
E007	E010	E011	E012	E013	E014
E015	E016	E018	E019	E020	E021
E022	E023	E025	E026	E027	E028
E029	E030	E031	E032	E033	E034
E036	E037	E046	E050	E051	E053
E054	E055	E056	E057	E058	E065
E066	E067	E068	E069	E070	E074
E077	E078	E080	E084	E086	E087
E088	E089				
W002	W003	W004	W005	W006	W007
W009	W011	W015	W017	W018	W019
W021	W022	W023	W024	W025	W027
W029	W030	W031	W037	W039	W040
W042	W043	W046	W047	W048	W051
W058	W059				

For the configurable relay operating mode “Alarm Conf.”, the following considerations are valid:

If the alarm condition is persistent, the alarm contact cyclically switches from its resting state to its activated state.

In the presence of W002 signalling (Input UV – input voltage below the limit of operation), the alarm contact switches to then reset itself at the end of the alarm signal. This means that during the reduced input voltage (display message “Waiting Sun”) the alarm contact remains in its resting position.

In the presence of W003, W004, W005, W006, W007 signalling, the alarm contact switches to then reset itself at the end of the alarm signal. This means that during the absence of grid voltage (display message “Missing Grid”) the alarm contact remains in its resting position.

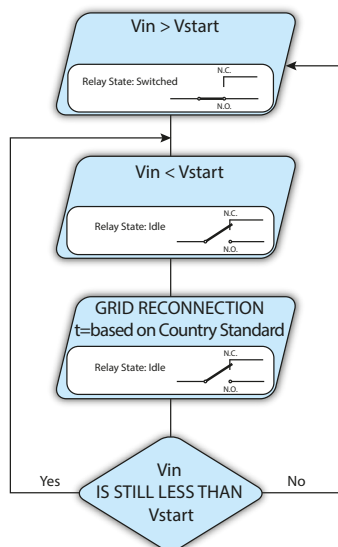

• **Crepuscular (display text “Crepuscular”)**

The relay is activated (status: switched) as soon as the inverter input voltage exceeds the activation voltage set.

The relay switch to rest position when the input voltage drops below 70% of the activation voltage set.

This mode is useful for disconnecting any output transformers that could have unnecessary consumption during the night.

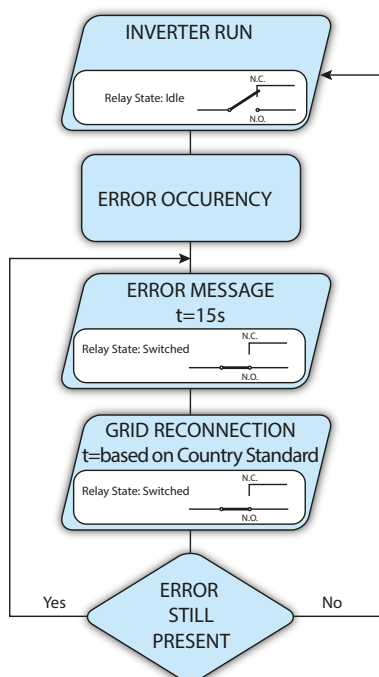

• **Alarm Latch (display text “Alarm Latch”)**

The relay is activated (status: switched) whenever an error (code Exxx) or a warning (code Wxxx) is present (see the table below). When the inverter returns to the normal operating state and reconnects with the grid, the contact returns to its position of rest.

Alarms for which the relay is activated

E001	E002	E003	E004	E005	E006
E007	E010	E011	E012	E013	E014
E015	E016	E017	E018	E019	E020
E021	E022	E023	E025	E026	E027
E028	E029	E030	E031	E032	E033
E034	E035	E036	E037	E046	E050
E051	E053	E054	E055	E056	E057
E058	E065	E066	E067	E068	E069
E070	E074	E077	E078	E080	E084
E086	E087	E088	E089		
W002	W003	W004	W005	W006	W007
W009	W011	W015	W017	W018	W019
W021	W022	W023	W024	W027	W029
W030	W036	W037	W039	W040	W042
W043	W046	W047	W048	W051	W058
W059					

If the alarm condition is persistent, the relay will remain activated (status:switched)



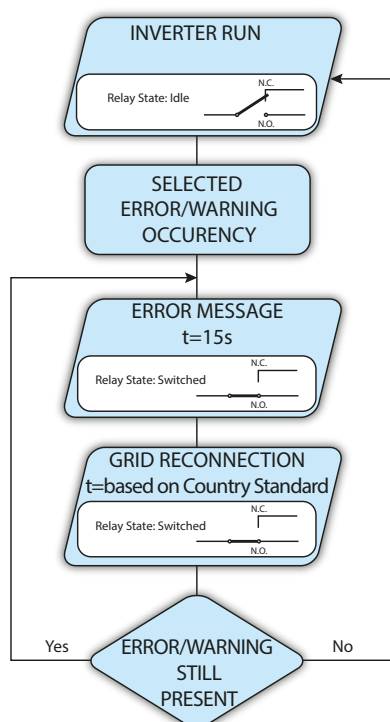

• Latch configurable alarm (display text “Al. Conf. Latch”)

The relay is activated (status: switched) whenever an error (code Exxx) or a warning (code Wxxx) is present from those selected from the list in the dedicated submenu **Alarm Config** (see the table below). When the inverter returns to the normal operating state and reconnects with the grid.

Alarms for which the relay is activated

E001	E002	E003	E004	E005	E006
E007	E010	E011	E012	E013	E014
E015	E016	E018	E019	E020	E021
E022	E023	E025	E026	E027	E028
E029	E030	E031	E032	E033	E034
E036	E037	E046	E050	E051	E053
E054	E055	E056	E057	E058	E065
E066	E067	E068	E069	E070	E074
E077	E078	E080	E084	E086	E087
E088	E089				
W002	W003	W004	W005	W006	W007
W009	W011	W015	W017	W018	W019
W021	W022	W023	W024	W025	W027
W029	W030	W031	W037	W039	W040
W042	W043	W046	W047	W048	W051
W058	W059				

If the alarm condition is persistent, the relay will remain activated (status:switched)

• Ext configurable alarm (display text “Al. Conf. Ext.”)

In this mode, it is possible to configure the behaviour of the alarm relay according to an external error table which can be setup with the Aurora Manager LITE software. In the table it is possible to select the alarms or warnings for which the alarm relay is activated (status: switched); for each individual alarm it is also possible to select the "Latch" or "No Latch" mode.

• Load Management (display text “Gogo rel. remote”)

It allows you to enable the Load Management functionality with which the relay is activated (status: switched) to a specific configurable power input threshold. Once this mode has been selected, the parameters for which the relay is activated have to be set (status: switched) on the dedicated section of internal webserver (see specific chapter).

Info

By selecting the **Info** menu, the following menus can be accessed:

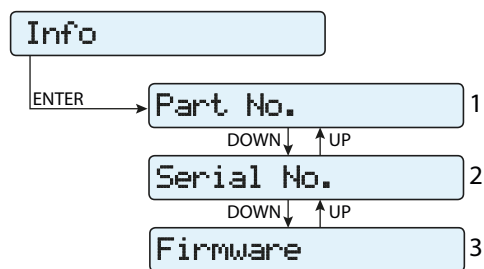

1. Part No.

Displays the model code

2. Serial number

Displays the serial number and week and year of manufacture of the equipment

3. Firmware

Lets you view the revision of the firmware installed on the equipment.



Display Menu

By selecting the **Display** menu, the following submenus can be accessed:



Settings

Selecting **Settings** brings up the first screen relating to the password. **The default password is "0000"**.

This can be changed by using the display buttons, following the same procedure as always:

- ENTER scrolls through the digits (from left to right)
- ESC returns to the previous digit (from right to left)
- Press ESC several times to return to the previous menus
- DOWN scrolls down the numerical scale (from 9 to 0)
- UP scrolls up the numerical scale (from 0 to 9)

After entering the password, press ENTER to access the information in this section:

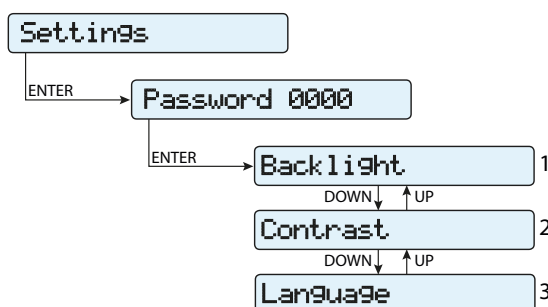

1. Backlight

This section of the menu allows you to set the backlighting display characteristics:

Mode:

ON: Light always on

OFF: Light always off

AUTO: Automatic backlight control. It activates each time a button is pressed and remains active for 30 seconds, after which time it gradually dims and deactivates.

2. Contrast

This section of the menu allows you to set the contrast of the display (on a scale of 1 to 9).

3. Language

Allows you to set the language you prefer for the menus

WLAN Logger Menu

By selecting the **WLAN Logger** menu, the following submenus can be accessed:

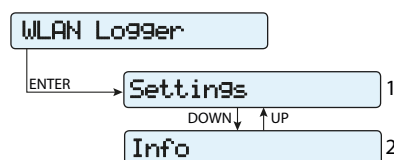

Settings

Selecting **Settings** brings up the first screen relating to the password. **The default password is "0000".**

This can be changed by using the display buttons, following the same procedure as always:

- ENTER scrolls through the digits (from left to right)
- ESC returns to the previous digit (from right to left)
- Press ESC several times to return to the previous menus
- DOWN scrolls down the numerical scale (from 9 to 0)
- UP scrolls up the numerical scale (from 0 to 9)

After entering the password, press ENTER to access the information in this section:

1. Restore AP

This section of the menu allows you to restore the "Access Point" mode of the wireless module of the inverter.



Info

By selecting the **Info** menu, the following menus can be accessed:

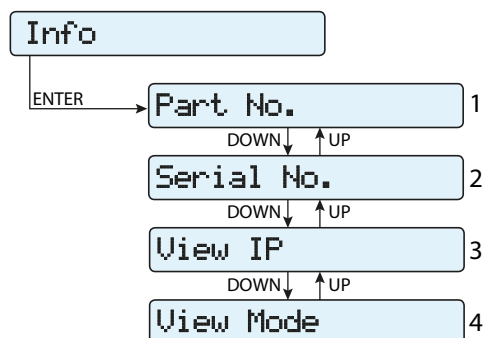

1. Part No.

Allows you to view the part number of the wireless board.

2. Serial number

Allows you to view the serial number, the week and year of manufacture of the wireless board.

3. View IP.

Allows you to view the IP address assigned to the wireless board.

4. View Mode

Allows you to view the operating mode of the wireless board ("Access Point" or "Host").



Maintenance

8

General conditions

Routine and periodic maintenance operations must only be carried out by specialized staff with knowledge of how to perform these tasks.



Maintenance operations must be performed with the apparatus disconnected from the grid (power switch open) and the photovoltaic panels obscured or isolated, unless otherwise indicated.



*For cleaning, DO NOT use rags made of filamentary material or corrosive products that may corrode the equipment or generate electrostatic charges.
Avoid temporary repairs. All repairs should be carried out using only genuine spare parts.
The maintenance technician is to promptly report any anomalies.*

DO NOT allow the equipment to be used if problems of any kind are found.



Always use personal protective equipment (PPE) provided by the employer and comply with local safety regulations.

Routine maintenance

Routine maintenance operations should not be considered obligatory, but rather as recommended in order to maintain the efficiency of the PV system.



It is recommended that maintenance operations are only performed by qualified personnel. The maintenance schedule may vary depending on the environmental conditions of the installation premises.

Table: routine maintenance

Annual visual inspections

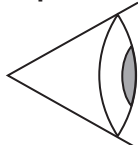

- Check that the inverter is operating properly, without any alarm signals
- Ensure that all the safety labels and symbols are visible
- Check the integrity of the cables, connectors and cable glands outside the inverter
- Check that the environmental conditions have not changed dramatically from those on installation

Annual operations



- Check the tightening of the cable glands and of the screw terminal blocks
- Check the front cover is fixed
- If there is no monitoring system, check the record of alarms and errors using the indications given in the manual in order to check recent malfunction signals

Annual cleaning



- Clean the equipment; in particular the heat sink (using compressed air)



Troubleshooting



Operations on the inverter to identify and address any faults may only be performed by the installer or by qualified personnel.

Internal Webserver and wireless communication troubleshooting

The following table gives a list of main and most common errors or problems relating to the wireless communication between inverter and user devices.

Problem	Possible causes	Solution
The internal webserver cannot be accessed.	ADMIN or USER password forgotten.	Reset the passwords by clicking on "Forgot your password"; The passwords can be reset after having entered the "Product Key" code that can be found on the "Wireless Identification Label".
The inverter is able to identify a wireless network but is unable to connect to it.	The signal between the inverter and the wireless router to which the board wants to connect is too weak.	Modify the position of the wireless antenna, the inverter or the router.
		Make sure that the inverter has not been installed near obstacles which could affect the communication with the wireless router (for example: metal cages or walls, walls in reinforced concrete, electromagnetic fields).
		Move the router as close as possible to the inverter.
The Inverter has not identified the wireless network to which connection is required.	The wireless network to which the inverter is to be connected, could require the user to enter a username and password to allow navigation (for example, with a public wireless network or a hotel).	Unfortunately the inverter cannot be connected to these types of wireless networks. Connect the inverter to an alternative wireless network.
	The wireless network to which the Inverter is to be connected, is set so as not to be identified (hidden network).	The Inverter is not able to connect to a hidden network. Set the wireless network to which the inverter is to be connected (visible network), then identify and connect the Inverter to the wireless network as normal.
The Inverter has not identified the wireless network to which connection is required.	The signal between the inverter and the wireless router to which the board wants to connect is too weak.	Modify the position of the wireless antenna, the inverter or the router.
		Make sure that the inverter has not been installed near obstacles which could affect the communication with the wireless router (for example: metal cages or walls, walls in reinforced concrete, electromagnetic fields).
		Move the router as close as possible to the inverter.
The wireless board does not communicate correctly with the inverter inside of which it is installed (inconsistency in the detected data read by the board), or when working in "Access Point Mode", it's not possible to access the internal webserver.	The wireless board of the inverter could be damaged.	Request a service intervention to check that the inverter wireless board is working correctly.
	Wrong Inverter Date/Time settings.	Check if Date/Time has correctly set on the inverter; correct it if necessary.
Alternating difficulties in the local connection to the internal webserver.	The inverter might not be correctly powered (for example, if the inverter is switched off at night, the internal webserver cannot be accessed).	Access to the internal webserver only when the inverter is correctly powered.
	The wireless connection signal between the device in use and the router or the Inverter, may not have sufficient power or it may be disturbed by obstacles which affect the communication.	Make sure that the signal between the wireless devices which interact with the inverter are sufficiently high and that any obstacles such as metal cages or walls, walls in reinforced concrete or strong electromagnetic fields do not affect communication.



Problem	Possible causes	Solution
Although the Inverter has been configured correctly in "Station Mode" and works correctly on the local network, no data has been transmitted to the Aurora Vision®.	The MAC address used to register the inverter on the Aurora Vision® platform is not the same as the actual address associated with the inverter.	Make sure that the MAC address registered on the Aurora Vision® platform is actually the one associated with the inverter. If it is not, modify the registered MAC address.
	The wireless network to which the Inverter is connected, could be protected by a Firewall which prevents the remote exchange of data with the Aurora Vision® platform.	Contact the network administrator in order to have the Firewall configured so that the remote exchange of data between the Inverter and the Aurora Vision® platform is allowed.
It is not possible to access the Internal webserver using the IP address when the inverter is operating in "Station Mode – DHCP".	An incorrect dynamic IP address is being used to access the Internal Webserver or the IP address could have been modified by the wireless router to which the inverter is connected.	Access the Internal Webserver using via "AP Mode" (refer to dedicated section to know how to connect via "AP Mode") and read the current IP Address in "NETWORK > WLAN" section.
		Access the Internal Webserver using the "Host Name" that could be obtained writing this url http://ABB-XX-XX-XX-XX-XX-XX.local replacing the "X" with the hex digits of the wireless MAC address of the inverter (it can be found on the "Wireless Identification Label" placed on the side of the inverter or applied during the commissioning phase to the quick installation guide on cover page). The DNS or multicast service must be enabled on router. Note: This connection method doesn't work on Android devices.
	The IP Address used to access the Internal Webserver was lost.	Access the inverter display menu WLAN Logger>Info>View IP to obtain the IP Address assigned by the router to the inverter. If possible, access the pages of the wireless router web server to which the inverter is connected and read the new dynamic IP address assigned to the Inverter.
	The wireless router doesn't allow the connection to local IP address. Typically this happen on company networks.	Contact the network administrator to allow the wireless router to connect to local IP address.
	The device doesn't allow the connection to local IP address. Typically this happen with company devices.	Contact the system administrator to allow the device to connect to local IP address.
Using an Android devices, a notification advise that internet connection is missing when trying to connect to the Access Point wireless network created by the inverter and ask for connection confirmation.	Known behavior of Android devices. Android OS always check if internet connection are available and ask for confirmation if it's not present.	Confirm the connection request in the notification of Android devices by clicking "Yes".
It is not possible to view the Pdf Auto-test report using an Ios devices.	Popup opening is not allowed on Ios browser.	Allow the popup opening in the browser settings of the Ios devices (A notification will advise you for enable popup when trying to view the pdf autotes report).









Alarm Messages of the Inverter







In order to understand and resolve warning (Wxxx) or error (Exxx) signals that appear in the Alarm section of the internal webserver or on the inverter's display, follow the table given in the following paragraph.











The equipment can notify errors/warnings in the Alarm section of the internal webserver or on the display only if the input voltage is greater than the Vdcm voltage (POWER Led flashing or lit; see chapter on operation). The messages and related codes are shown in the Alarm section of the internal webserver or on the display.

The following table gives the complete list of errors/warnings relating to string inverters. Some error/warning codes may not be used depending on the inverter model installed.

- Code on display - Error message - Signal	Name of Alarm and Cause	Solution
- R-Iso Low - Ground Fault -  GFI LED	Ground fault of photovoltaic generator: The alarm is generated when a leakage current to ground is detected in the DC section of the system.	<ul style="list-style-type: none"> • Measure the insulation resistance using a megohmmeter positioned in the photovoltaic field (positive terminal short-circuited at the negative pole) respect to ground. The measurement is strongly influenced by the environmental conditions, so must be made under the same conditions in which the error occurred. - If the value measured is lower than 1 megaohm, a check must be carried out by a technician/installer on the photovoltaic generator to identify and eliminate the problem. - If the value measured is higher than 1 megaohm and the error signal persists, contact customer assistance.
- No code - SET COUNTRY or NO NATION -  No LED	SET COUNTRY or NO NATION: Indicates that in the installation phase the grid standard was not set on the inverter.	<ul style="list-style-type: none"> • Set the grid standard of the country of installation following the instructions given in this manual for the inverter. - If the signal persists also after the grid standard has been set, contact customer assistance.
- No code - Missing Grid -  Alarm LED	Missing Grid: The inverter displays the "Missing Grid" message when it does not record output voltage (AC side).	<ul style="list-style-type: none"> • Check the grid voltage on the inverter's AC terminal block. - Should it be absent, check any protection work on the line and the presence of grid voltage on the supply point.
- No code - Memory Fail -  Alarm LED lamp.	Memory fail: The inverter displays the "Memory Fail" message when it records a communication problem with the memory board on which the inverter saves the daily value of energy produced.	<ul style="list-style-type: none"> • Remove the memory board and check the welding of all the connector's terminals. Subsequently reinsert the memory board and check that it is correctly inserted into the dedicated slot - If the signal persists also following the above checks, contact customer assistance.
- No code - Waiting Sun -  Power LED lamp.	Waiting Sun: The inverter displays the "Waiting Sun" message when, following a W001 and/or W002 notice, the voltage from the photovoltaic generator is less than the activation voltage (Vstart).	<ul style="list-style-type: none"> • Check the input voltage on the inverter. - If it does not exceed Vstart, check for the presence of sufficient irradiation and the correct composition of the system. - If it exceeds Vstart, contact customer assistance
- W001 - Sun Low -  Alarm LED	Insufficient irradiation (Low input voltage on switching on the inverter): Incorrect configuration of the PV generator or an "on the limit" configuration for the inverter's minimum input voltage.	<ul style="list-style-type: none"> • Check the input voltage on the inverter. - If it does not exceed Vstart, check for the presence of sufficient irradiation and the correct composition of the system. - If it exceeds Vstart, contact customer assistance
- W002 - Input UV -  Alarm LED	Insufficient irradiation (Low input voltage on switching off): Incorrect configuration of the photovoltaic generator or an "on the limit" configuration for the inverter's minimum input voltage	Check the input voltage on the inverter. <ul style="list-style-type: none"> - If it does not exceed Vstart, check for the presence of sufficient irradiation and the correct composition of the system. - If it exceeds Vstart, contact customer assistance



- Code on display - Error message - Signal	Name of Alarm and Cause	Solution
- W003 - Grid Fail -  Alarm LED	Parameters of grid voltage outside range: This error signal occurs when during the inverter's normal operation the grid parameters exceed the limits imposed by the grid standard set on the inverter and by the grid operator or the utility: - Grid voltage absent (after the signal the inverter goes to "Missing Grid") - Unstable grid voltage (down or up) - Unstable grid frequency	<ul style="list-style-type: none"> • Check the grid voltage on the inverter. - Should it be absent, check for absence of grid voltage on the supply point. - If, on the other hand, the voltage tends to rise (when the inverter is connected) there is high line or grid impedance. • Check the grid voltage also on the supply. - If it is high, it means that there is high grid impedance. In this case, ask the operator to adjust the grid voltage. If the operator authorises a change to the inverter's parameters, you can set the new limits into the "Inverter>Settings>Service" display menu or into "Setup>Setup AC side" of the internal webserver (refer to dedicated sections of this manual for further information). - If the voltage at the point of supply is much lower than that measured on the inverter, it is necessary to adjust the line (inverter-contactor). - If the voltage and the grid frequency come back within the limits (also when the inverter is connected to the grid) contact customer assistance
- W004 - Grid OV -  Alarm LED	Grid overvoltage: This error signal occurs when during the inverter's normal operation the grid voltage exceeds the maximum limit set by the operator.	<ul style="list-style-type: none"> • Check the grid voltage on the inverter. If the voltage tends to rise (when the inverter is connected), there is a problem of high line or grid impedance. • Check the grid voltage also on the supply. - If it is high, it means that there is high grid impedance. In this case, ask the operator to adjust the grid voltage. If the operator authorises a change to the inverter's parameters, you can set the new limits into the "Inverter>Settings>Service" display menu or into "Setup>Setup AC side" of the internal webserver (refer to dedicated sections of this manual for further information). - If the voltage at the point of supply is much lower than that measured on the inverter, it is necessary to adjust the line (inverter-contactor). - If the voltage and the grid frequency come back within the limits (also when the inverter is connected to the grid), contact customer assistance
 - W005 - Grid UV -  Alarm LED	Grid undervoltage: This error signal occurs when during the inverter's normal operation the grid voltage exceeds the minimum limit set by the operator.	<ul style="list-style-type: none"> • Check the grid voltage on the inverter. • Check the grid voltage also on the supply: - If it is high, it means that there is high grid impedance. In this case, ask the operator to adjust the grid voltage. If the operator authorises a change to the inverter's parameters, agree the new limits with customer assistance - If the voltage at the point of supply is much lower than that measured on the inverter, it is necessary to adjust the line (inverter-contactor). - If the voltage and the grid frequency come back within the limits (also when the inverter is connected to the grid), contact customer assistance
- W006 - Grid OF -  Alarm LED	Grid over-frequency: This error signal occurs when during the inverter's normal operation the grid frequency exceeds the maximum limit set by the operator.	<ul style="list-style-type: none"> • Check the grid frequency in the inverter. • Check the grid frequency also on the supply: - - If the voltage and the grid frequency come back within the limits (also when the inverter is connected to the grid), contact customer assistance
- W007 - Grid UF -  Alarm LED	Grid under-frequency: This error signal occurs when during the inverter's normal operation the grid frequency exceeds the minimum limit set by the operator.	<ul style="list-style-type: none"> • Check the grid frequency in the inverter. • Check the grid frequency also on the supply: - - If the voltage and the grid frequency come back within the limits (also when the inverter is connected to the grid), contact customer assistance
- W010 * - Fan Fail -  Alarm LED lamp. *not visualised on display	Fan Fail: This error occurs when there is a malfunction in the fan/fans inside the inverter.	<ul style="list-style-type: none"> • Error inside the inverter and cannot be checked externally. - If the alarm repeats persistently, contact customer assistance.

- Code on display - Error message - Signal	Name of Alarm and Cause	Solution
- W011 - Bulk UV -  Alarm LED	Low "Bulk" voltage (DC-DC circuit): The alarm (which is a warning and not an error) is generated when the voltage at the heads of the bulk capacitors does not reach the threshold for the operation of the inverter (internal unchangeable threshold).	<ul style="list-style-type: none"> • Raise the value of the activation voltage (Vstart) if the problem at the time of the inverter's grid connection (Using the formulas $0,7 * V_{mp, stc}$ or $0,6 * V_{oc, stc}$). • If the problem occurs in the morning, try to raise the value of the activation voltage (Vstart) (Using the formulas $0,7 * V_{mp, stc}$ or $0,6 * V_{oc, stc}$). • Check the input voltage on the inverter. - If it does not exceed Vstart, check for the presence of sufficient irradiation and the correct composition of the system. - If it exceeds Vstart, contact customer assistance
- W012 * - Batt. Low -  Alarm LED *not visualised on display	Battery Low: The inverter displays the "Battery Low" message when it records a voltage for the buffer battery which is too low.	<ul style="list-style-type: none"> • Check that the date/time are set correctly and, if they are not, set them. Subsequently arrange to completely switch off the inverter (on both AC and DC) and wait a few minutes. Finally, restart the inverter and check whether the date/time are now correctly set or whether they have reset to 01/01/2000. In this case replace the battery with the inverter completely switched off (section AC and DC side) being careful to maintain the polarity
- W013 * - Clock Fail -  Alarm LED lamp. *not visualised on display	Clock Fail: The alarm occurs when there is a difference of over 1 minute in the time displayed compared to the internal time of the microprocessors and indicates a malfunction of the clock circuit.	<ul style="list-style-type: none"> • completely switch off the inverter (on both AC and DC) and wait a few minutes. Finally, restart the inverter and check whether the date/time are now correctly set or whether they have reset to 01/01/2000. In this case replace the battery with the inverter completely switched off (section AC and DC side) being careful to maintain the polarity. - If the alarm repeats persistently, contact customer assistance.
- W015 - Island Detect. -  Alarm LED	Disconnection due to Anti-Islanding: The inverter has been improperly connected to an island grid.	<ul style="list-style-type: none"> • Check that the grid to which the inverter is connected is not an island grid. - If the grid to which the inverter is connected is an island grid, switch the inverter off and then on again: if the problem persists, contact customer assistance.
- W017* - String Err. -  Alarm LED lamp. * (only for models with monitored string fuses)	Error recorded in measuring string currents: Damaged string protection fuse(s)	<ul style="list-style-type: none"> • Check with a multimeter the state of the fuses (positioned on the fuse boards). - If one or more fuses is open, arrange to replace them and check that the input current on the string(s) does not exceed the rating of the fuses (should parallel strings have been made outside the inverter). - If there are no damaged string fuses and the inverter continues to show the alarm message check whether the settings to be made through the Aurora Manager software are correct (presence or absence of one or more input strings).
- W018 * - SPD DC Err -  Alarm LED lamp. * (only for models with monitored SPD)	Intervention of overvoltage surge arresters on DC side: Damaged overvoltage surge arresters positioned on DC side	<ul style="list-style-type: none"> • Observe the inspection window on each surge arrester (DC side). If it is red, the surge arrester is damaged and the cartridge must be replaced. - If the alarm status persists, even if all the surge arresters have a green inspection window, contact customer assistance.
- W019 * - SPD AC Err -  Alarm LED lamp. * (only for models with monitored SPD)	Intervention of overvoltage surge arresters on AC side: Damaged overvoltage surge arresters positioned on AC side	<ul style="list-style-type: none"> • Observe the inspection window on each surge arrester (AC side). If it is red, the surge arrester is damaged and the cartridge must be replaced. - If the alarm status persists, even if all the surge arresters have a green inspection window, contact customer assistance.
- W022 * - Reactive power mode changed -  No LED *not visualised on display	Variation in means of managing reactive power: Variation in the means of managing reactive power; this change can be made through the display or advanced configuration software.	The variation in the means of managing reactive power is done directly by the customer/installer and is not an error. The information is only saved on the historic record of the events memorised by the inverter
- W023 * - date/time changed -  No LED *not visualised on display	Variation in the inverter's date and time: Variation of the inverter's date and time; this change can be made through the display or advanced configuration software.	<ul style="list-style-type: none"> • The variation in the inverter's date and time is done directly by the customer/installer and is not an error. The information is only saved on the historic record of the events memorised by the inverter
- W024 * - Energy data reset -  No LED *not visualised on display	Zeroing of the statistical energy data memorised in the EEPROM: Reset of the energy data saved in the inverter; this operation can be handled through the display or advanced configuration software.	The zeroing of the partial energy values memorised by the inverter is done directly by the customer/installer and is not an error. The information is only saved on the historic record of the events memorised by the inverter <ul style="list-style-type: none"> • The notice may also occur on substitution of the Memory Card where the statistical production data is saved















- Code on display - Error message - Signal	Name of Alarm and Cause	Solution
- W026 * - AFDD user reset - ⊗ No LED *not visualised on display	Reset of the Arc Fault error: Manual reset of the Arc Fault error; this operation can be made through the display or advanced configuration software.	<ul style="list-style-type: none"> The reset of the Arc Fault error is done directly by the customer/installer and is not an error. The information is only saved on the historic record of the events memorised by the inverter
- W027 * - Latch-Manual reset - ⊗ No LED *not visualised on display	Resetting of the Latch alarm conditions: Manual reset of the Latch alarm conditions; this operation can be made through the display or advanced configuration software.	<ul style="list-style-type: none"> The reset of the Latch alarm conditions is done directly by the customer/installer and is not an error. The information is only saved on the historic record of the events memorised by the inverter
- W046 - Grid conn. fault - ● Alarm LED	Connection to the grid unsuccessful The alarm is logged when a Missing grid or Input UV error occurs or due to the manual disconnection of the inverter during the grid connection sequence.	<ul style="list-style-type: none"> Once the error occurs, the inverter tries to return to normal operation. If the problem persists after a number of attempts to connect the inverter, switch the inverter off and then on again. If the problem persists (once the inverter has been switched off and back on again), contact customer assistance.
- W047 - Update Incomplete - ● Alarm LED	FW update method unsuccessful The alarm occurs when a firmware update has not been completed.	<ul style="list-style-type: none"> Complete any pending firmware updates. If the problem persists once the firmware updates have been completed, switch the inverter off and on again. If the problem persists (once the inverter has been switched off and back on again), contact customer assistance.
- W048 - Periodic GridOff - ● Alarm LED	Automatic disconnection from the grid due to time limit: If the inverter exceeds the set grid connection time limit set by the grid standard, it will automatically have to carry out a disconnection and reconnection to the grid to carry out the Riso test.	<ul style="list-style-type: none"> The presence of this alarm is not an error as the automatic disconnection is prescribed by safety regulations. If the inverter disconnects in a shorter time than expected, contact customer assistance.
- W049 * - Global-Settings Event - ⊗ No LED *not visualised on display	Variation of the grid standard Variation of the inverter's grid standard; this change can be made through the display or advanced configuration software.	<ul style="list-style-type: none"> The variation in the inverter's grid standard is done directly by the customer/installer and is not an error. The information is only saved on the historic record of the events memorised by the inverter
- W058 - System Frozen - ● Alarm LED	Converter in locked state: The converter lock state is connected to an installation phase in which the starts-up and grid connection conditions are not yet present.	<ul style="list-style-type: none"> Complete the commissioning phase of the inverter. If the problem persists (once the commissioning phase has been completed and the inverter has been switched off and back on again), contact customer assistance.
- E001 - Input OC - ● Alarm LED	Input over-current (photovoltaic generator): The alarm occurs when the inverter's input current exceeds the inverter's threshold for maximum input current.	<ul style="list-style-type: none"> Check whether the composition of the PV generator enables input current which exceeds the maximum threshold allowed by the inverter and that the configuration of the inputs (independent or in parallel) is carried out correctly. If both checks are positive, contact customer assistance.
- E002 - Input OV - ● Alarm LED	Input overvoltage (photovoltaic generator): The alarm is generated when the input voltage (from the PV generator) exceeds the inverter's threshold of maximum input voltage. The alarm occurs before reaching the absolute threshold over which the inverter is damaged. When the inverter's input voltage exceeds the overvoltage threshold, the inverter will not start up due to the generation of the alarm.	<ul style="list-style-type: none"> It is necessary to measure the input voltage inside the inverter with a voltmeter. If it is higher than the maximum voltage of the operating range, the alarm is genuine and it is necessary to check the configuration of the PV generator. If the voltage has also exceeded the maximum input threshold the inverter could be damaged. If it is lower than the maximum voltage of the operating range, the alarm is caused by an internal malfunction and it is necessary to contact customer assistance.
- E003 - No Parameters - ● Alarm LED	DSP initialisation error: The main microcontroller cannot initialise correctly the two DSPs (booster stage and inverter stage). The error is caused by communication problems on the inverter's internal bus.	<ul style="list-style-type: none"> Error inside the inverter and cannot be checked externally. If the problem persists (once the inverter has been switched off and back on again), contact customer assistance.
- E004 - Bulk OV - ● Alarm LED	"Bulk" over-voltage (DC-DC circuit): Error inside the inverter. The alarm is raised when the voltage at the heads of the bulk capacitors exceeds the overvoltage threshold (internal unchangeable threshold).	<ul style="list-style-type: none"> The alarm may be triggered by causes external to the inverter: <ul style="list-style-type: none"> An excessive input voltage can be recorded as a condition for bulk overvoltage. In this case it is advisable to check the inverter's input voltage and should this value be close to the input OV threshold, review the configuration of the photovoltaic generator. Excessive grid voltage could cause the bulk voltage to rise in uncontrolled fashion with a consequent protection intervention and hence generation of the alarm. In these cases the alarm is transitory and the inverter automatically restarts The alarm may be triggered by causes inside the inverter and in this case it is necessary to contact customer assistance.



- Code on display - Error message - Signal	Name of Alarm and Cause	Solution
- E005 - Comm.Error - ● Alarm LED	Communication error inside the inverter: The alarm occurs when there are communication problems between the control devices inside the inverter.	• Error inside the inverter and cannot be checked externally. - If the problem (once the inverter has been switched off and back on) persists, contact customer assistance.
- E006 - Output OC - ● Alarm LED	Output overcurrent: The alarm occurs when the inverter's output current exceeds the inverter's threshold for maximum output current.	• Error inside the inverter and cannot be checked externally. - If the problem (once the inverter has been switched off and back on) persists, contact customer assistance.
- E007 - IGBT Sat - ● Alarm LED	Saturation recorded on the IGBT components: The alarm occurs when one of the inverter's active devices is in a saturated state.	Once the error occurs, the inverter tries to return to normal operation. - Should the error occur sporadically, it may be caused by a brusque transition of the grid voltage or of the input voltage, but is not due to a malfunction by the inverter. - If the error is connected to an internal breakdown, it will continue to appear and so it is necessary to contact customer assistance.
- E009 - Internal error - ● Alarm LED	Error inside the inverter: Error inside the inverter	• Error inside the inverter and cannot be checked externally. - If the problem (once the inverter has been switched off and back on) persists, contact customer assistance.
- E010 - Bulk Low - ● Alarm LED	Low "Bulk" voltage (DC-DC circuit): The alarm may be triggered by causes external to the inverter: a reduced input voltage on the inverter (just above the activation voltage) but which is not accompanied by a sufficient availability of power from the photovoltaic generator (typical condition of the stages with limited irradiation)	- If the error signal occurs sporadically, it may be due to causes external to the inverter (limited irradiation and so limited power availability from the PV generator). - If the problem occurs systematically also in conditions of high irradiation and with input voltage which is significantly higher than the activation voltage, contact customer assistance.
- E011 - Ramp Fail - ● Alarm LED	Long wait for "Booster" regime to start: Error internal to inverter relating to start up time for DC-DC circuit regime (Booster)	• Error inside the inverter and cannot be checked externally. - If the problem (once the inverter has been switched off and back on) persists, contact customer assistance.
- E012 - DcDc Fail - ● Alarm LED	Error in the "Booster" circuit (DC-DC side) recorded by the "Inverter" circuit (DC-AC side): Error internal to inverter relating to operation of the DC-DC circuit regime (Booster)	• Error inside the inverter and cannot be checked externally. - If the problem persists (once the inverter has been switched off and back on again), contact customer assistance.
- E013 - Wrong Mode - ● Alarm LED	Incorrect configuration of inputs (set in parallel rather than independent): The alarm is generated solely when the inverter is configured with parallel inputs. In this particular configuration the inverter checks the input voltage of each of the two channels and if the two voltages differ by more than 20Vdc, the alarm is raised .	• Check that the setting of the "IN MODE" switch is specifically set to "PAR" and that the bridges between the two input channels have been included. - If the configuration of the inverter is correct, check that the input strings have the usual number of standard panels of the usual brand and with the same inclination/orientation. - If both the configuration of the inverter and the characteristics of the PV generator conform with the specifications, contact customer assistance.
- E014 - Over Temp. - ● Alarm LED	Excessive temperature inside the inverter: External temperature over 60°C. This parameter also depends on the power which the inverter must supply since the measurement of temperatures is done internally and is influenced by the heat dissipated by the components of the inverter itself	• Check that the inverter is not exposed to direct sunlight. Wait for the temperatures to which the inverter is exposed to return to the operating range and for the inverter to cool down. - If the problem (once the ambient temperature has returned to the range) persists, contact customer assistance. Remember to wait the time needed to allow the inverter to cool down
- E015 - Bulk Cap Fail - ● Alarm LED	Fault recorded on the "Bulk" capacitor: Error inside the inverter relating to a problem in the bulk capacitors.	• Error inside the inverter and cannot be checked externally. - If the problem persists (once the inverter has been switched off and back on again), contact customer assistance.
- E016 - Inverter Fail - ● Alarm LED	Error in the "Inverter" circuit (DC-AC side) recorded by the "Booster" circuit (DC-DC side): The alarm is generated when a problem is recorded in the inverter circuit (DC/AC)	• Error inside the inverter and cannot be checked externally. - If the problem persists (once the inverter has been switched off and back on again), contact customer assistance.
- E017 - Start Timeout - ● Alarm LED	Long wait for "Inverter" regime to start up: Error internal to inverter relating to start-up time for the DC-AC circuit regime (Inverter) • The alarm may be triggered by causes external to the inverter: a reduced input voltage on the inverter (just above the activation voltage) but which is not accompanied by a sufficient availability of power from the photovoltaic generator (typical condition of the stages with limited irradiation)	- If the error signal occurs sporadically, it may be due to causes external to the inverter (limited irradiation and so limited power availability from the PV generator). - If the problem occurs systematically also in conditions of high irradiation and with input voltage which is significantly higher than the activation voltage, contact customer assistance.





- Code on display - Error message - Signal	Name of Alarm and Cause	Solution
- E018 - Ground Fault - ● GFI LED	High leakage current measured on the DC side (photovoltaic generator): The alarm is generated when, during normal operation of the inverter, a leakage current to ground is detected in the DC section of the system. It is also possible that the inverter generates the alarm E018 message also due to AC leakage currents connected to the capacitive nature of the photovoltaic generator compared to ground.	<ul style="list-style-type: none"> • Measure the insulation resistance using a megohmmeter positioned in the photovoltaic field (positive terminal short-circuited at the negative pole) compared to ground. The measurement is strongly influenced by the environmental conditions, so must be made under the same conditions in which the error occurred. - If the value measured is lower than 1 megaohm, a check must be carried out by a technician/installer on the photovoltaic generator to identify and eliminate the problem. - If the value measured is higher than 1 megaohm and the error signal persists, contact customer assistance.
- E019 - Ileak sense.fail - ● Alarm LED	Failure of test on sensor to measure the leakage current (DC side): Before connecting to the grid the inverter runs a autotest regarding the sensor for the leakage current. The test is carried out by "forcing", in the sensor of the leakage current, a current with a known value: the microprocessor compares the value read with the known value. The error is generated if the comparison between the read value and the known value during the test does not fall within the allowed tolerance.	<ul style="list-style-type: none"> • Error inside the inverter and cannot be checked externally. By its nature, the alarm only occurs prior to connection to the grid - If the problem (once the inverter has been switched off and back on) persists, contact customer assistance.
- E020 - Self Test Error 1 - ● Alarm LED	Failure of the test on the relay of the "Booster" (DC-DC circuit): Before connecting to the grid the inverter carries out internal tests. One of these tests concerns the correct operation of the booster relay. The test is carried out by "forcing" the switching of the relay and checking its operation. The error is generated if a problem is found in actioning the relay.	<ul style="list-style-type: none"> • Error inside the inverter and cannot be checked externally. By its nature, the alarm only occurs prior to connection to the grid - If the problem persists (once the inverter has been switched off and back on again), contact customer assistance.
- E021 - Self Test Error 2 - ● Alarm LED	Failure of the test on the inverter's relay (DC-AC circuit): Before connecting to the grid the inverter carries out internal tests. One of these tests concerns the correct operation of the inverter relay. The test is carried out by "forcing" the switching of the relay and checking its operation. The error is generated if a problem is found in actioning the relay.	<ul style="list-style-type: none"> • Error inside the inverter and cannot be checked externally. By its nature, the alarm only occurs prior to connection to the grid - If the problem persists (once the inverter has been switched off and back on again), contact customer assistance.
- E022 - Self Test Error 4 - ● Alarm LED	Timeout of the tests undertaken on the relays inside the inverter: Execution time for the autotest carried out on the relay of the DC_AC (inverter) circuit too high. It may indicate a problem connected to the aforementioned relays	<ul style="list-style-type: none"> • Error inside the inverter and cannot be checked externally. - If the problem persists (once the inverter has been switched off and back on again), contact customer assistance.
 - E023 - DC in error - ● Alarm LED	Feeding of direct current to grid outside of range: The error is generated if the continuous component of the current supplied to the grid exceeds the threshold of 0.5% of the normal operating current. In any case the inverter is not blocked due to the E023 error, but tries to reconnect to the grid. The sporadic repetition of the error is a sign of serious grid distortions or sharp irradiation changes, while systematic repetition of the error signal will indicate a breakdown on the inverter	Once the error occurs, the inverter tries to return to normal operation. <ul style="list-style-type: none"> - Should the error occur sporadically, it may be caused by a brusque transition of the grid voltage or of the input voltage, but is not due to a malfunction by the inverter. - If the error is connected to an internal breakdown, it will continue to appear and so it is necessary to contact customer assistance.
- E024 - Internal error - ● Alarm LED	Error inside the inverter: Error inside the inverter	<ul style="list-style-type: none"> • Error inside the inverter and cannot be checked externally. - If the problem persists (once the inverter has been switched off and back on again), contact customer assistance.

- Code on display - Error message - Signal	Name of Alarm and Cause	Solution
- E025* - Riso Low -  Alarm LED *not visualised on display	Low value of insulation resistance: Before connecting to the grid the inverter measures the insulation resistance of the PV generator compared to ground. Should the measurement of the insulation resistance be below 1Mohm, the inverter does not connect to the grid and shows the "Riso Low" error. The causes may be: - PV panel(s) damaged; - Junction box(es) of the panels not correctly sealed, so as to permit infiltration by water and/or humidity; - Problems in connections between panels (not perfectly fit); - Poor quality of cable joints; - Presence in the DC section of unsuitable or damaged overvoltage surge arresters outside the inverter (reduced ignition voltage compared to the characteristics of the strings of the PV generator); - Presence of humidity inside any junction box	<ul style="list-style-type: none"> • Measure the insulation resistance using a megohmmeter positioned in the photovoltaic field (positive terminal short-circuited at the negative pole) compared to ground. The measurement is strongly influenced by the environmental conditions, so must be made under the same conditions in which the error occurred. - If the value measured is lower than 1 megaohm, a check must be carried out by a technician/installer on the photovoltaic generator to identify and eliminate the problem. - If the value measured is higher than 1 megaohm and the error signal persists, contact customer assistance.
- E026 - Vref Error -  Alarm LED	Internal reference voltage outside of range: Wrong measurement of reference voltage inside inverter	<ul style="list-style-type: none"> • Error inside the inverter and cannot be checked externally. - If the problem persists (once the inverter has been switched off and back on again), contact customer assistance.
- E027 - Error Meas V -  Alarm LED	Grid voltage outside of range: Error in the internal measurement of grid voltage (set by law) in order to have a redundant measurement (2 measurements on the same parameter made by two different circuits)	<ul style="list-style-type: none"> • Error inside the inverter and cannot be checked externally. - If the problem persists (once the inverter has been switched off and back on again), contact customer assistance.
- E028 - Error Meas F -  Alarm LED	Grid frequency outside of range: Error in the internal measurement of grid frequency (set by law) in order to have a redundant measurement (2 measurements on the same parameter made by two different circuits)	<ul style="list-style-type: none"> • Error inside the inverter and cannot be checked externally. - If the problem persists (once the inverter has been switched off and back on again), contact customer assistance.
- E029 - Mid Bulk OV -  Alarm LED	Internal overvoltage on the measurement of the "Mid bulk": Error inside the inverter (only triphase models)	<ul style="list-style-type: none"> • Error inside the inverter and cannot be checked externally. - If the problem persists (once the inverter has been switched off and back on again), contact customer assistance.
- E030 - Error Meas Ileak -  Alarm LED	High leakage current (DC side): Error in the internal measurement (made when the inverter is grid connected) of the leakage current of the DC side (PV generator) compared to ground (set by law) in order to have a redundant measurement (2 measurements on the same parameter made by two different circuits)	<ul style="list-style-type: none"> • Error inside the inverter and cannot be checked externally. - If the problem persists (once the inverter has been switched off and back on again), contact customer assistance.
- E031 - Error Read V -  Alarm LED	Output relay damaged: Measurement of internal voltage on heads of the output relay outside of range. There is too great a difference in voltage between the input and output of the grid connection relay.	<ul style="list-style-type: none"> • Error inside the inverter and cannot be checked externally. - If the problem persists (once the inverter has been switched off and back on again), contact customer assistance.
- E032 - Error Read I -  Alarm LED	Imbalanced output currents: Measurement of the imbalance in the output voltage (carried out across the three phases) outside of range (only in triphase models)	<ul style="list-style-type: none"> • Error inside the inverter and cannot be checked externally. - If the problem persists (once the inverter has been switched off and back on again), contact customer assistance.
- E033 - UTH -  Alarm LED	Low ambient temperature: Temperature outside the inverter below -25°C	<ul style="list-style-type: none"> • Wait for the temperatures to which the inverter is exposed to return to the operating range. - If the problem persists, contact customer assistance. Remember to wait the time needed to allow the inverter to warm up
- E034 - Interlock fail -  Alarm LED	"IGBT" circuitry not ready: Error inside the inverter	<ul style="list-style-type: none"> • Error inside the inverter and cannot be checked externally. - If the problem persists (once the inverter has been switched off and back on again), contact customer assistance.
- E035* - Remote Off -  Alarm LED *not visualised on display	Inverter awaiting "remote ON" command: The inverter has been switched off remotely (remote OFF) and remains awaiting the signal which will switch it back on (Remote ON)	<ul style="list-style-type: none"> • Switch the inverter back on remotely. If the unit does not switch back on, disable the remote off/on function and switch the equipment off completely and subsequently switch it back on. - If the problem persists (once the Remote ON/OFF function from the display has been reactivated), contact customer assistance.



- Code on display - Error message - Signal	Name of Alarm and Cause	Solution
- E036 - Vout Avg error - ● Alarm LED	Average of the measurements of grid voltage outside of range: The average value of the grid voltage (sampled every 10 minutes) does not fall within the permitted ranges. The grid voltage in the point connected to the inverter is too high. This may be caused by too high a grid impedance. In the final stage of the timeout, the inverter limits the power to check whether the grid voltage has stabilised into regular parameters. If this does not happen, the inverter disconnects from the grid	<ul style="list-style-type: none"> • Check the grid voltage in the connection point to the inverter. - If the grid voltage differs from the range due to the conditions of the distribution grid, ask the operator to adjust the grid voltage. If the operator authorises a change to the inverter's parameters, agree the new limits with customer assistance
E046 - String self test fail - ⊗ No LED	Error during the automatic check of the string voltages (only in models with the "fuse-control" board): In some inverter models it is possible to carry out the check test of the polarity of the strings connected to the input (e.g.:TRIO-20.0/27.6kW). This error signal occurs when, during the test stage, an inverted string is recorded	<ul style="list-style-type: none"> • Section the inverter and check the polarity of the string(s) which the inverter has recorded as inverted. - Once all the strings have been correctly connected, activate the system once again; the inverter will once again check the correct polarity of the string inputs at the end of which it will carry out the checks for the grid connection. - If the problem persists (once the inverter has been switched off and back on again), contact customer assistance.
E049 - AC FF Error - ● Alarm LED	Error in the "AC feed-forward" circuit: Error inside the inverter	<ul style="list-style-type: none"> • Error inside the inverter and cannot be checked externally. - If the problem persists (once the inverter has been switched off and back on again), contact customer assistance.
E050 - AFDD Activated - ● GFI LED	Arc Fault protection activated: Possible photovoltaic arc detected on the DC side.	<ul style="list-style-type: none"> • If it is the first time this problem has occurred, press the ESC button for 5 seconds and wait for the unit to restart. - If the problem persists (once the inverter has been switched off and back on again), contact customer assistance.
E053 - AFDD Fault - ● Alarm LED	Arc Fault board autotest failed: Problem detected during the AFDD board autotest phase.	<ul style="list-style-type: none"> • Error inside the inverter and cannot be checked externally. - If the problem persists (once the inverter has been switched off and back on again), contact customer assistance.
E054 - AFDD comm. Fault - ● Alarm LED	Arc Fault board communication error: Error on the RS485 serial communication detected between the inverter and the AFDD board.	<ul style="list-style-type: none"> • Error inside the inverter and cannot be checked externally. - If the problem persists (once the inverter has been switched off and back on again), contact customer assistance.
E055 - AFDD wrong conf. - ● Alarm LED	Arc Fault board parameter reading error: Error in the parameter reading by the system.	<ul style="list-style-type: none"> • Error inside the inverter and cannot be checked externally. - If the problem persists (once the inverter has been switched off and back on again), contact customer assistance.
E056 - Over Temp. (from external box) - ● Alarm LED	Excessive temperature measured inside the inverter's wiring box: High internal temperature. This error relates to the temperature measured on external boxes (e.g.:TRIO-20.0/27.6kW).	<ul style="list-style-type: none"> • Check that the inverter is not exposed to direct sunlight. Wait for the temperatures to which the inverter is exposed to return to the operating range and for the inverter to cool down. - If the problem (once the ambient temperature has returned to the range) persists, contact customer assistance. Remember to wait the time needed to allow the inverter to cool down
 E057 - Vbulk reading error - ● Alarm LED	Input voltage (Vin) higher than booster voltage (Vbulk): The error occurs if the input voltage exceeds the Bulk voltage (voltage on the DC-DC circuit inside the inverter)	<ul style="list-style-type: none"> • It is necessary to measure the input voltage inside the inverter with a voltmeter. - If it is higher than the maximum voltage of the operating range, the alarm is genuine and it is necessary to check the configuration of the PV generator. If the voltage has also exceeded the maximum input threshold the inverter could be damaged. - If it is lower than the maximum voltage of the operating range, the alarm is caused by an internal malfunction and it is necessary to contact customer assistance.
E058 - Pin vs Pout check error - ● Alarm LED	Error in the check of Pin vs Pout: The error occurs if the difference between the measured value of input power and that of output power is greater than the limit imposed internally to the inverter.	<ul style="list-style-type: none"> • Error inside the inverter and cannot be checked externally. - If the problem persists (once the inverter has been switched off and back on again), contact customer assistance.
E077 - Internal Error - ● Alarm LED	Error in the system configuration: Error inside the inverter	<ul style="list-style-type: none"> • Error inside the inverter and cannot be checked externally. - If the problem persists (once the inverter has been switched off and back on again), contact customer assistance.
E078 - Riso Test fail - ● Alarm LED	Riso test error: Problem detected during the Riso test phase.	<ul style="list-style-type: none"> • Error inside the inverter and cannot be checked externally. - If the problem persists (once the inverter has been switched off and back on again), contact customer assistance.
E079 - Wrong Sequence - ● Alarm LED	Incorrect Phases connection (Only triphase models) The phases have not been connected correctly to the AC output	<ul style="list-style-type: none"> • Invert two of the phases of the network wiring to the AC terminal block of the inverter.

- Code on display - Error message - Signal	Name of Alarm and Cause	Solution
E081 - Internal Error -  GFI LED	Inverter fault / Incomplete inverter closing: Fault inside the inverter or incomplete inverter closing (front cover missing or not tightened, cable glands missing or incorrectly tightened, environmental protection IP65 not guaranteed)	<ul style="list-style-type: none"> • If the problem has occurred during the installation phase or during the inverter maintenance phase (therefore the cover has been removed or the cable glands have been acted upon), carry out the following operations: <ul style="list-style-type: none"> - Disconnect the AC grid and DC input from the inverter and check for the front cover and all the cable glands, also checking their correct tightening to ensure environmental protection IP65; reconnect the AC grid and the DC input and attempt to switch the inverter on; if the problem persists, contact customer assistance : - If the front cover and all cable glands are present, disconnect the AC grid and DC input from the inverter and wait 15 minutes at a safe distance, then open the inverter cover and if no smoke/smell of burning is present, check the integrity of the components or the presence of moisture or other abnormal conditions; reconnect the AC grid and DC input and attempt to switch on the inverter; if the problem persists contact customer assistance. • If the problem has occurred after installation or after an inverter maintenance phase (therefore the cover has NOT been removed or the cable glands have NOT been acted upon), disconnect the AC grid and the DC input from the inverter and contact customer assistance.
E084 - BackFeed OC -  Alarm LED	Return current to photovoltaic field: The error occurs if the input voltage is particularly low (typically in the evening in conditions of low irradiation) and indicates a return current from the inverter to the photovoltaic panels).	If the error occurs in the evening or in conditions of low irradiation, it must not be considered a problem but a protection intervention for the photovoltaic field. - If the problem occurs with good irradiation conditions, switch the inverter off and back on again; if the error persists, contact customer assistance.
E089 - Wrong Wiring -  Alarm LED	Incorrect grid wiring connection on Stand Alone: The error occurs if the grid cables have been incorrectly connected to the Stand Alone output.	<ul style="list-style-type: none"> • Check that the cables on the Stand Alone output have been installed correctly.



Power limitation messages

The equipment can signal possible output power limitations which may occur on the basis of:

- settings made by the user
- settings required by the grid standard of the country of installation
- protective devices inside the inverter

The messages are shown on the display.

The following table gives the complete list of power limitation messages relating to string inverters. Some messages may not be used depending on the inverter model installed.

- Message on display	Name of Derating and Cause	Solution
- LIMxxx% CODE:00	<p>Power limitation: The message indicates that the user has set an output power limitation for the inverter. LIM xxx% = Power reduction percentage Examples: LIM 100% = no power limitation LIM 50% = limitation to 50% of the output nominal power</p>	<ul style="list-style-type: none"> • Check the limitation value set in the "Settings > Power Reduction" menu
- LIMxxx% CODE:01	<p>Power limitation for over-frequency: The message indicates that the user has set a power limitation due to over frequency in order to reduce the maximum output power of the inverter when the grid frequency exceeds certain limits. LIM xxx% = Power reduction percentage Examples: LIM 100% = no power limitation LIM 50% = limitation to 50% of the output nominal power</p>	<ul style="list-style-type: none"> • Check the limitation value set in the "Settings > Service Power > OF Derating" menu
- LIMxxx% CODE:02	<p>Power limitation for over-voltage: The message indicates that the user has set a power limitation due to overvoltage (parameter U >(10 min)) in order to reduce the maximum output power of the inverter when the reading of the average grid voltage exceeds certain limits. The sampling of readings is done every 10 minutes (U >(10min)). LIM xxx% = Power reduction percentage Examples: LIM 100% = no power limitation LIM 50% = limitation to 50% of the output nominal power</p>	<ul style="list-style-type: none"> • Check the limitation value set in the "Settings > Service Power > U > (10 min) Der." menu
- LIMxxx% CODE:03	<p>Anti-islanding power limitation: The message indicates that a power limitation is active since an "islanding" condition has been recorded. LIM xxx% = Power reduction percentage Examples: LIM 100% = no power limitation LIM 50% = limitation to 50% of the output nominal power</p>	<ul style="list-style-type: none"> • If the inverter remains connected to the grid and the limitation is active, contact customer assistance
- LIMxxx% CODE:04	<p>Power limitation due to low grid voltage: The message indicates that an output power limitation may occur since a low grid voltage (AC) condition has been recorded. LIM xxx% = Power reduction percentage Examples: LIM 100% = no power limitation LIM 50% = limitation to 50% of the output nominal power</p>	<ul style="list-style-type: none"> • Check that the grid voltage is lower than the minimal voltage. Should this condition persist, contact the grid operator to resolve the problem.



- Message on display	Name of Derating and Cause	Solution
- LIMxxx% CODE:05	<p>Power limitation due to excess temperature: The message indicates that a power limitation is active since an excess temperature condition has been recorded inside the inverter (This parameter depends also on the power which the inverter must provide since the measurement of temperatures is taken internally and is influenced by the heat dissipated by the components of the inverter itself). LIM xxx% = Power reduction percentage Examples: LIM 100% = no power limitation LIM 50% = limitation to 50% of the output nominal power</p>	<ul style="list-style-type: none"> • Check that the inverter is not exposed to direct sunlight. Wait for the temperatures to which the inverter is exposed to return to the operating range and for the inverter to cool down. - If the problem (once the ambient temperature has returned within the range) persists, contact customer assistance.
- LIMxxx% CODE:06	<p>Power limitation for input over-voltage: The message indicates that a power limitation is active since an input overvoltage (DC) has been recorded. LIM xxx% = Power reduction percentage Examples: LIM 100% = no power limitation LIM 50% = limitation to 50% of the output nominal power</p>	<ul style="list-style-type: none"> • It is necessary to measure the input voltage inside the inverter with a voltmeter. - If it is higher than the maximum voltage of the operating range, the alarm is genuine and it is necessary to check the configuration of the PV generator. If the voltage has also exceeded the maximum input threshold the inverter could be damaged. - If it is lower than the maximum voltage of the operating range, the alarm is caused by an internal malfunction and it is necessary to contact customer assistance.



Dismantling the inverter



Before attempting any work on the inverter, wait for stored energy to be discharged and for parts to cool.

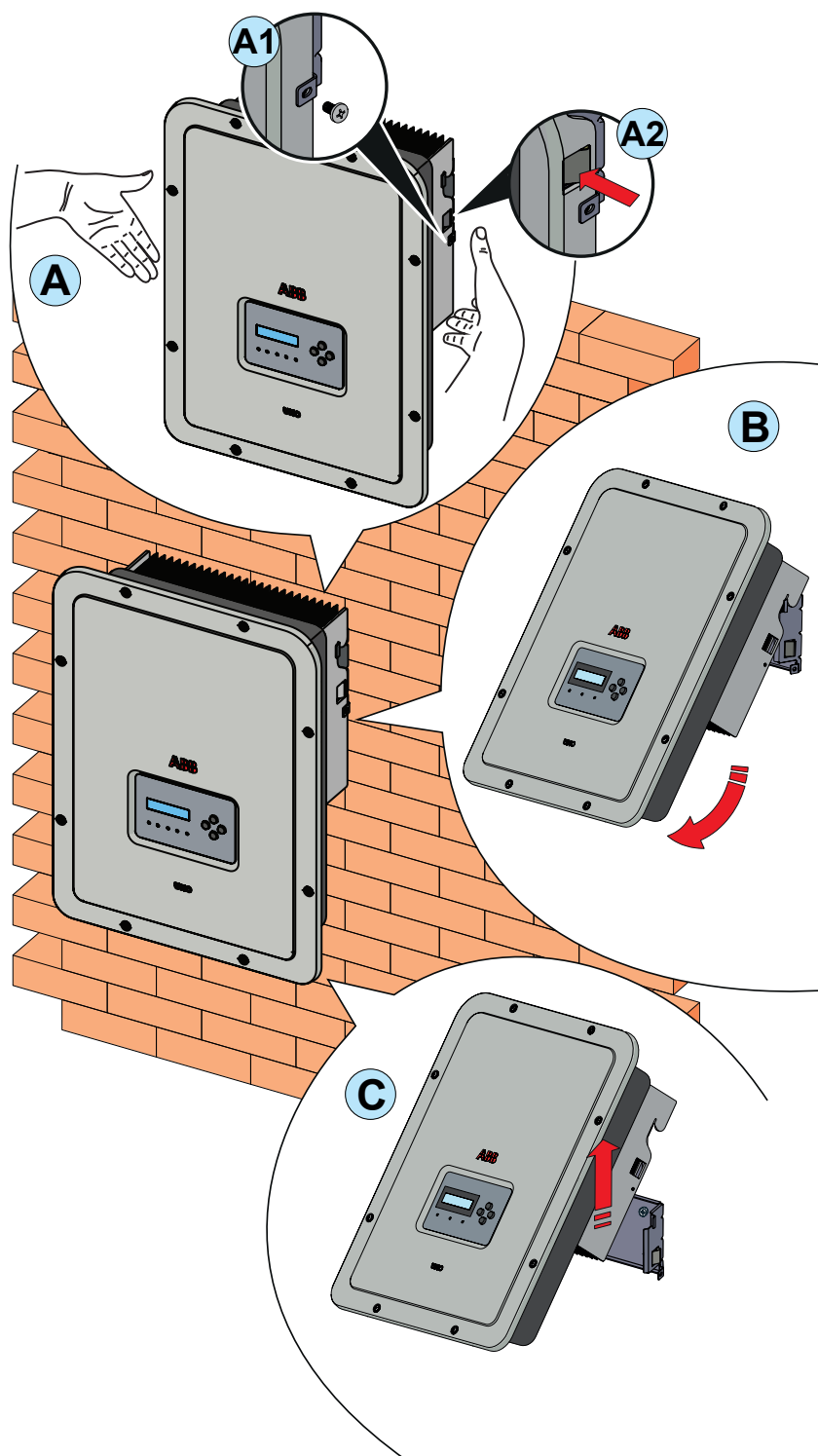

- Open the external DC and AC disconnects switches.

- Disconnect any power supplies that may be connected to the UNO-DM-COM KIT and UNO-DM-PLUS-COM ETHERNET KIT.

- Disconnect any cables from the inverter:

- DC cables

- AC cables

- Any cables that may be connected to the UNO-DM-COM KIT UNO-DM-PLUS-COM ETHERNET KIT

- Proceed to unlock the inverter from the bracket by unscrewing the two (one each side) locking screws ⑬ and pulling forward the lower part of the inverter (figures ① and ②).

If on the bracket are present the lateral lock springs (one for each side of the inverter), pushing it and pulling forward the lower part of the inverter, at the same time (figures ② and ③).

- Remove the inverter from the wall bracket pulling it up (figure ④).

Registration on “Registration” website and calculation of second-level password (Service menu, Admin Plus)

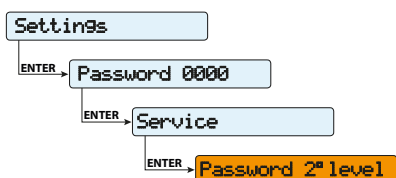

In order to obtain the second-level password needed to access the inverter's display service menu or to obtain the “Admin Plus” privileges in the internal webserver, it is necessary to go through the following stages:

Stage 1 - Collection of information relating to the inverter.

Collect the following information relating to each inverter for which you wish to have a password:

- **S/N** - Serial number of the inverter. This information can be found on the product label giving the identity details of the inverter or on the display by accessing the “INFORMATION” menu→Serial No.”

The serial number consists of 6 digits (the last 6 in models with a label giving a 10-digit S/N)

- **WK** - Production week. This information can be found on the product label giving the identity details of the inverter or on the display by accessing the “INFORMATION” menu→Serial No.”

The production week consists of 4 figures, indicating the week (first 2 digits) and the year of production (last 2 digits)

- **Update Version** - This information is available only for some inverter models and can be found on the display by accessing the menu “INFORMATION→Firmware”.

Stage 2 - Registration on <https://registration.abbsolarinverters.com>

- Go online and access <https://registration.abbsolarinverters.com>
- Set the desired language and click on the specific icon to start registration

- Insert the personal data requested and end the registration stage
- An email will be sent to the email address used with a link to complete the registration process.
- Once the registration process is over, a further email will be sent with the password to access the website.

The password obtained enables access also to the advanced “Installer” mode present on the configuration software for inverters. The configuration software can be downloaded in a specific section of the website <https://registration.abbsolarinverters.com>



Stage 3 - Request for second level password

- Go online and access <https://registration.abbsolarinverters.com>
- Insert the Username (corresponding to the email used during registration) and the Password obtained at the end of Stage 2

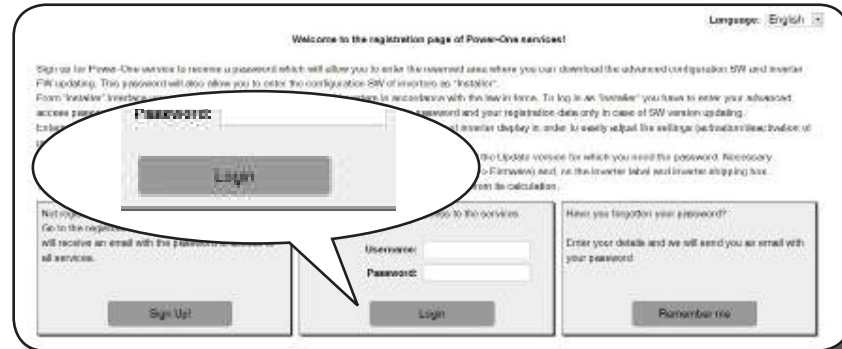

- Access the section dedicated to requesting the second-level password

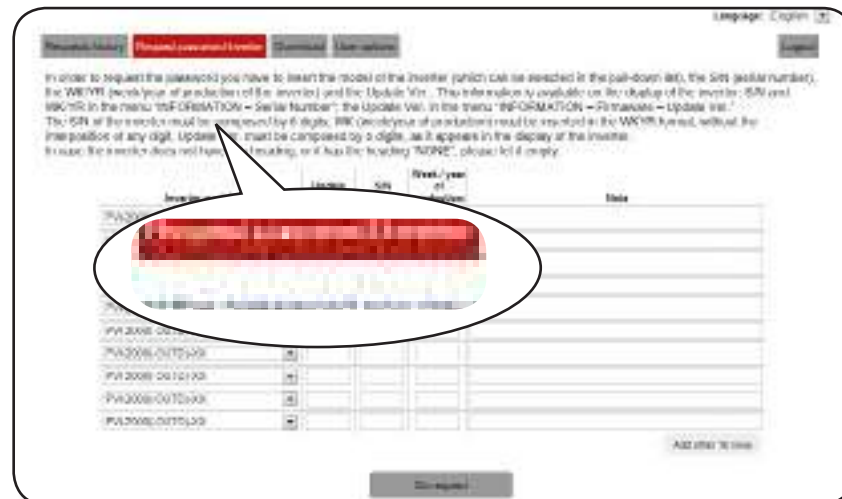

- Choose the inverter model from the drop-down list and insert Update Ver., Serial Number and Week of Production of the inverter which were obtained previously (Stage 1)

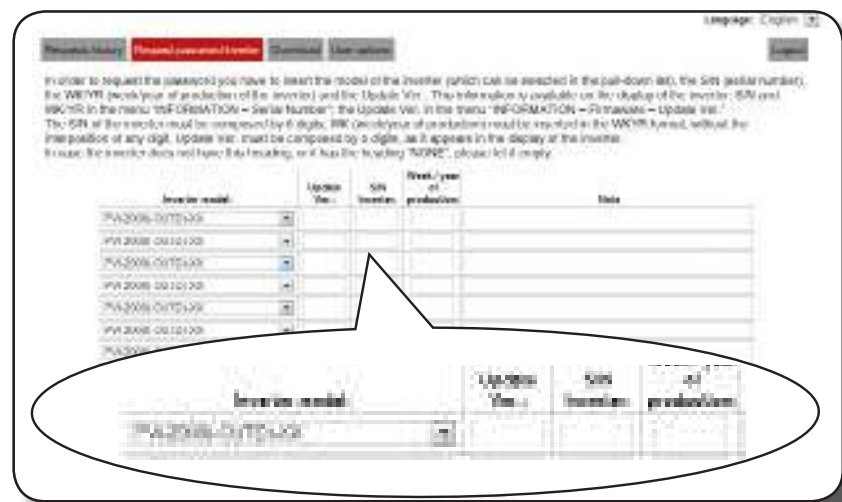

- Click on icon to request password.

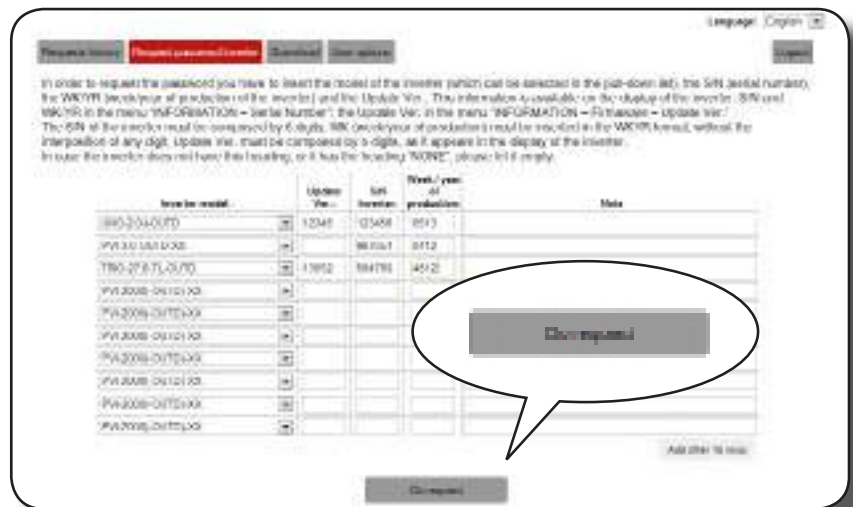

Should there be an error in inputting data, the fields containing the error will be highlighted in red. If, on the other hand, the data are correct, the passwords will be shown in a new window and at the same time sent to the email address used for registration.



The second-level password enables access to the service menu or to obtain the "Admin Plus" privileges which allows the inverter's sensitive parameters to be changed. Proceed to changing the aforementioned parameters only when requested by the grid operator or by customer assistance.



Resetting the remaining time for grid standard variation from display

From the moment a valid grid standard is set and the inverter is switched on, there is a time period of 24 hours available in which modifications to the grid standard setting can be made.



The 24 hours are only counted while the inverter is switched on. Check that the date and time are correctly set. If these settings are incorrect, it may not be possible to access the "Reset Country" menu which allows the timer to be reset.

Once this period has passed, changing the standard will be "blocked" and it will be necessary to carry out the following procedure to reset the remaining time and once again, have 24 hours of operation available in which to select a new grid standard.



You can check how much time remains before the "Country Select" button is blocked, by accessing the menu SYSTEM > SETTINGS > Country Select. > Residual Time.



1. Access the "SYSTEM > SETTINGS" menu by entering the first level password (default **0000**)

2. Access the "Country Select" submenu. > Reset Country" entering the second level password to restore the 24 hours of operation in which it is possible to change the grid standard.



The password required for accessing the "Service" menu can be obtained by registering on the website <https://registration.abbsolarinverters.com>. Refer to the dedicated section on this topic in the manual



3. After having reset the timer, it will be possible to change the grid standard with the one required in the menu SYSTEM > SETTINGS > Country Select. > Set Std.

Verification of ground leakage

In the presence of anomalies or report of ground fault (where provided), there may be a ground leakage from the PV generator (DC side).

To check this, measure the voltage between the positive pole and ground and between the negative pole (of the PV generator) and ground using a voltmeter whose input accepts a voltage sufficient for the dimensions of the photovoltaic generator.

Behaviour of a system without leakage

Due to the capacitive effect of the PV generator, during the first moments that the voltmeter is connected between one of the two poles and ground, it will measure a voltage of about $V_{oc}/2$, which will tend to stabilize to around 0V if there is no ground leakage, as shown in the graph below:

The internal resistance of the voltmeter tends to zero the voltage present on the PV generator due to the capacitive effect.

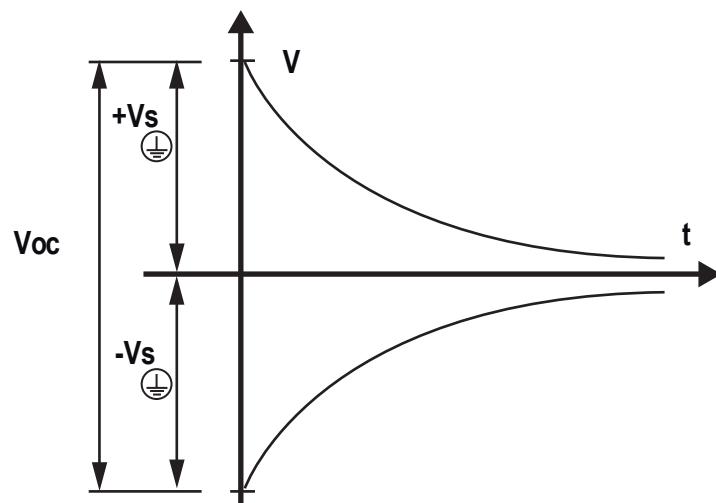

How to make the measurement:

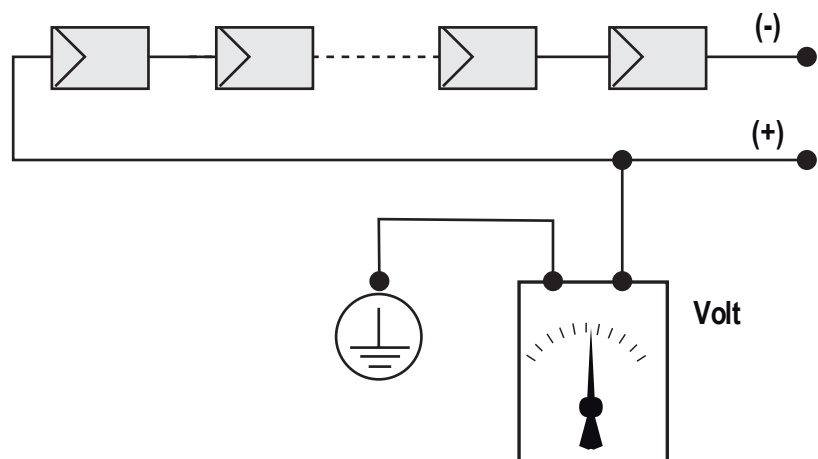

Behaviour of a system with leakage

If the voltage measured between one of the two poles and ground does not tend to 0V and stabilizes on a value, there is a ground leakage from the PV generator.

Example: When the measurement is made between positive pole and ground, a voltage of 200V is measured.

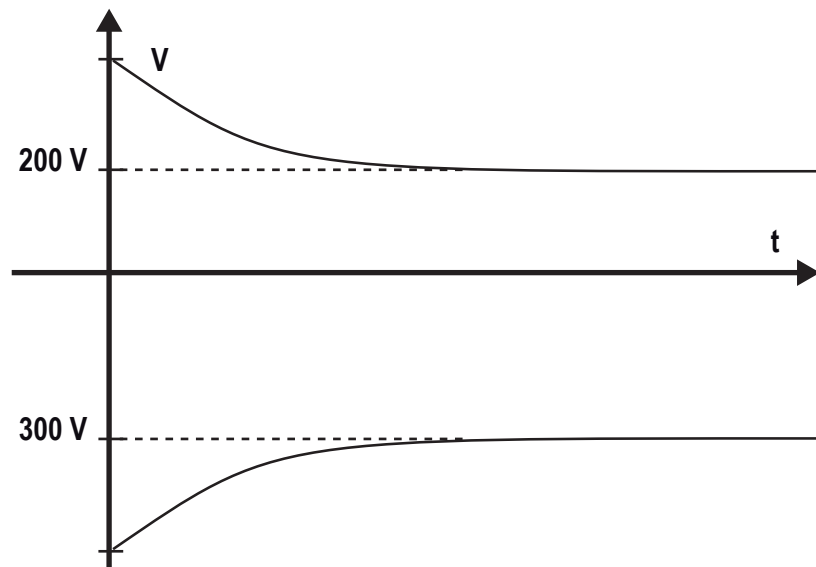

This means that if the system is made up of 10 modules in series and each one supplies 50V, the leakage can be located between the 4th and 5th PV module.

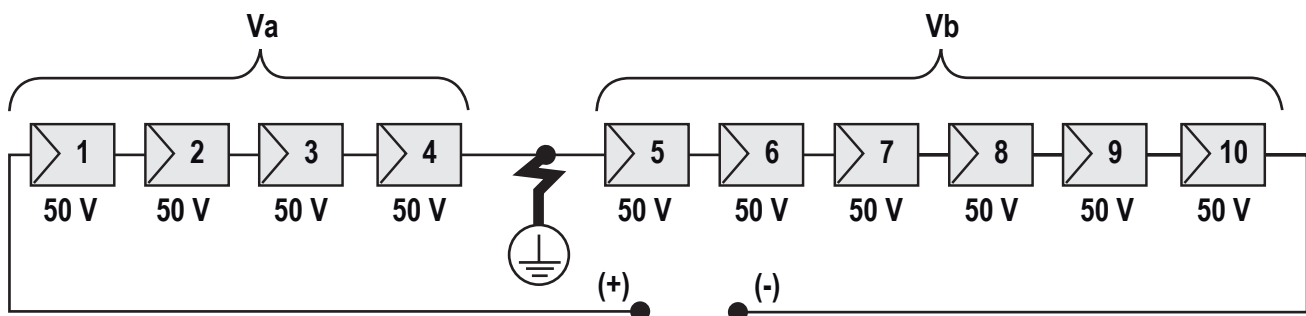

V_a = voltage measured between + pole and \oplus = 200V

V_b = voltage measured between - pole and \oplus = 300V

In all measurements with \oplus , the ground of the inverter is indicated.

Measuring the isolation resistance of the PV generator.

To measure the isolation resistance of the PV generator compared to ground (⊕), the two poles of the PV generator must be short-circuited (using a suitably sized selector).

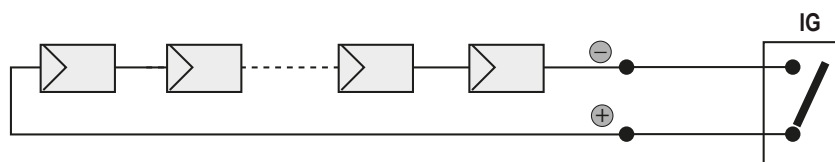

Once the short-circuit has been made, measure the isolation resistance (Riso) using a megohmmeter positioned between the two shorted poles and ground (of the inverter).

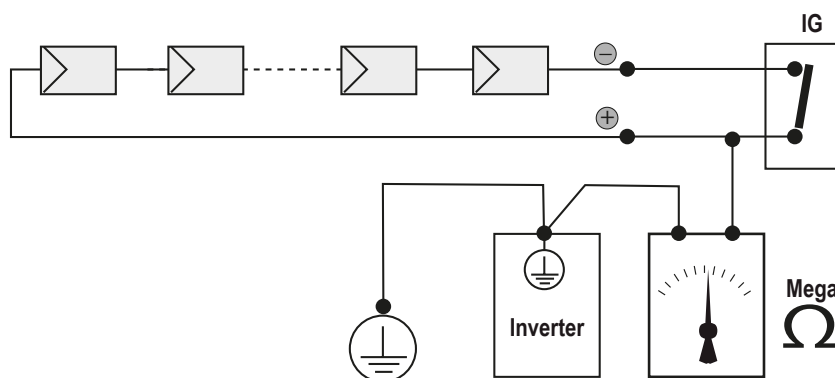

MODELS - TL (without isolation transformer). If the measured isolation resistance (Riso) is less than 500 MΩ, the inverter may not connect to the grid because of low isolation of the PV generator to ground.

MODELS - I (with isolation transformer). If the measured isolation resistance (Riso with floating input poles compared to ground or QF=1 with grounding of one of the two inlet poles) is lower than 0.2 MΩ, the inverter will not connect to the grid due to low isolation of the PV generator to ground.

The isolation resistance can be affected by the environmental conditions the PV generator is in (E.g.: PV modules wet from damp or rain), and therefore the measurement must be made immediately after the anomaly is detected



Storage and dismantling

Storage of an uninstalled inverter for long periods

If the inverters to be stored for a long period of time before installation, check that it is correctly packed.

The equipment must be stored in well-ventilated, indoor areas, in a non-corrosive environment that doesn't damage the inverter's components.

Have the inverter inspected before installation: interior components, covers and gaskets.

Storage of an installed inverter for long periods of non-use

If an inverter in the field is to be left unused, confirm all external openings and connectors have water tight seals or cap. Securely close all locks. If it's in a humid environment, install dessicant in the interior since the inverter is not seeing heat cycles each day.

Restarting after a long period of non-use requires a thorough inspection of the inverter's interior, exterior and wiring to the PV field and grid (and removal of any dessicant). In some cases, oxidation and dust that has settled inside the equipment must be removed.

Disposal



ABB CANNOT be held responsible for disposal of the equipment (cables, batteries, etc.). The customer must dispose of these items, some of which be harmful to the environment, in accordance with the local regulations

Dispose of the various types of materials at facilities that are suitable for the purpose.

Table: component composition

COMPONENT	CONSTRUCTION MATERIAL
Frame, brackets, supports	Arc-welded steel FE37
Casing or covers	Arc-welded steel FE37, aluminum
Gaskets and seals	Rubber / Teflon / Viton
Electrical cables	Copper / Rubber
Backup battery	Nickel / Lead/ Lithium

Attachments

9

Port and network services used by the inverter

IP Network Services

Any network connected to the inverter must allow traffic to pass on the following ports. Network firewall rules (if present) must allow responses to the inverter over existing TCP connections.

Direction	Service/Port	Protocol	Description
Out	ssh/22	Tcp	For remote debugging by ABB service personnel, the inverter utilizes encrypted SSH Remote Login Protocol. To allow service personnel remote access to the inverter, this port has to be opened in any firewall and forwarded to the inverter. (preferred)
Out	domain/53	Tcp/udp	The inverter must be able to resolve domain names, to ensure scalability and dynamic changes on the Internet (DNS). (required)
Out	https/443	Tcp	As an HTTP client, the inverter uses SSL/TLS protocol connections to Aurora Vision [®] servers for secure communication. The inverter uses this port for all services, including data transmission, firmware upgrade, configuration management, and remote command transmission. (required)
Out	dhcp/67, dhcp/68	Udp	If DHCP service is not available, static network information must be assigned to the inverter (preferred)
Out	ntp/123	Udp	The inverter uses this port for network time services (NTP). (preferred)



Network Hosts

The inverter will connect to the following hosts. Some servers owned by ABB, and others are customer or ISP servers. Servers listed as owned by "Customer IT/ISP" must be configured in the inverter using either DHCP or as static network information.

Host	Purpose	Port	Owner/Manager
platform.auroravision.net	Data, configuration	TCP:443	ABB
gw1.auroravision.net and/or apt.fatspaniel.net	Inverter firmware upgrade	TCP:443	ABB
Site dependent	DHCP (optional)	UDP:67, UDP:68	Customer IT/ISP
Site dependent	DNS	UDP:53, TCP:53	Customer IT/ISP

Inverter network configuration

The inverter requires a valid network configuration in order to operate. This information can either be provided by a DHCP server provided by the customers network (the default), or the inverter can be configured with static network information. Regardless of how the inverter is configured, the following information is required.

Configuration	Purpose
IP Address	Allows the inverter to take part in the local network. This does not need to be a public IP address. In most cases this is a private IP address.
Subnet mask	Used to determine if two computers are on the same network.
Gateway	The IP address of the computer which will forward network traffic from the local network to an external network
DNS Server	The IP address(es) of the computer(s) which resolve domain names.



Further information

For more information on ABB solar products and services,
visit www.abb.com/solarinverters

Contact us

www.abb.com/solarinverters

